



DAVID BARR BUILDER

OFFICE:

7160 HWY. 281 N.

UNIT #13

SPRING BRANCH, TX 78070

210-867-3760

DAVIDBARRBUILDER.COM





CONTACTS

DAVID BARR

210-867-3760

DAVID.BARR@DAVIDBARRBUILDER.COM

OWNER

KYLE BARR

210-279-1176

KYLE.BARR@DAVIDBARRBUILDER.COM

BUILDER

GABI OROSZ

210-748-0439

GABI@DAVIDBARRBUILDER.COM

BUILDER

CAMERON ARCHER

210-896-2432

CAMERON@DAVIDBARRBUILDER.COM

BUILDER

BIDS@DAVIDBARRBUILDER.COM

PLANS@DAVIDBARRBUILDER.COM

INVOICES@DAVIDBARRBUILDER.COM

WARRANTY@DAVIDBARRBUILDER.COM





PRE-CONSTRUCTION INFORMATION

PLUMBING

GAS SERVICE

TANK ONLY – STARTING PRICE
120-GALLON TANK - UPRIGHT
GAS-PLUMBING DROP

UPGRADES

*50-GAL. GAS WATER HEATER	QUOTED
*TANKLESS GAS WATER HEATER	QUOTED
*GAS DROPS	QUOTED
**BOOSTED WATER PUMP	QUOTED
QTY. 2-INCLUDED - HOSE BIBS	QUOTED
GARAGE SINK	QUOTED

ELECTRICAL

ELECTRICAL WALK-THROUGH IS CONDUCTED BEFORE SHEETROCK.

FLOOR PLUG: (ONLY PRIOR TO POUR)
WELDER PLUG-IN: (VOLTAGE? AMP? LOCATION?)
RV PLUG-IN: (VOLTAGE? AMP? LOCATION?)
(DOES NOT INCLUDE TRENCHING.)
USB OUTLET:
DIMMER CONTROLS:
OUTLET:
SWITCH CONTROLLED OUTLET:
6" LED CAN LIGHT:

ALARM SYSTEM

INCLUDED

ONE (1) KEYPAD
ALARM CONTACTS ON ALL EXTERIOR DOORS
TWO (2) MOTION DETECTORS
ONE (1) SIREN
ONE (1) BACK-UP BATTERY

UPGRADES

EACH ADDITIONAL KEYPAD
EACH ADDITIONAL MOTION DETECTOR
EACH GLASS BREAK SENSOR





PRE-CONSTRUCTION INFORMATION

RV SEPTIC

EXTRA COSTPRE-PLAN***EXTRA PERMITTING***

REVERSE OSMOSIS DROPS

EXAMPLES

HOUSE REFRIGERATOR PRE-PLUMBED TO RO.

GARAGE REFRIGERATOR PRE-PLUMBED TO RO.

ICE MACHINE PRE-PLUMBED TO RO.





DESIGN PROCESS INFORMATION

BEING PREPARED FOR THE DESIGN PROCESS. PLEASE HAVE CONCEPTS, DESIGN AESTHETICS, PICTURES, IDEAS, ALL ORGANIZED AND PREPARED.

THE DESIGN PROCESS FOR THE ENTIRE HOME SHOULD ONLY TAKE 3-HRS. HOWEVER, WE DO ALLOW A MAXIMUM OF 5-HRS.

THERE ARE SOME SELECTIONS THAT HAVE TO BE MADE AT MULTIPLE LOCATIONS. STONE YARD AND COUNTERTOPS.

MAXIMUM OF 5 HOURS OF DESIGN

- CAN BE BROKEN INTO MULTIPLE SESSIONS (NO MORE THAN 3)
- SESSIONS SHOULD BE SCHEDULED AND COMPLETED WITHIN A 2 WEEK TIME FRAME.
- TIME OVER 5 HOURS: \$200/HR.

UPGRADES MUST BE PAID FOR, BEFORE DAVID BARR BUILDER WILL PROCEED WITH PURCHASING AND/OR INSTALLATION.

MAKE CHECKS PAYABLE TO DB BUILDER, LLC.

CHECKS MAY BE MAILED OR DROPPED OFF AT OUR OFFICE. WIRING ALSO AVAILABLE.

SELECTION SHEET MUST BE SIGNED AND DATED UPON AT THE END OF THOSE 5HRS. SELECTIONS SHOULD BE MADE AS QUICKLY AS POSSIBLE.

ONCE SELECTION SHEET HAS BEEN COMPLETED, SIGNED, AND DATED; CHANGES WILL ONLY BE ACCEPTED WITH A **\$250 CHANGE FEE** FOR EACH CHANGE, IN ADDITION TO THE COST OF THE PRODUCT. THE COMPLETION DATE WILL ALSO BE RE-EVALUATED AND REVISED TO BEST REFLECT THE NEW PROJECTED COMPLETION DATE.



WINDOWS

Earthwise 300 Series Windows



Traditional brick mould exterior gives home an attractive look

FEATURES AND BENEFITS

- Available in Single Hung, Horizontal Glider, Picture Window and Architectural Shapes
- Fusion-welded frame and sashes for strength and durability
- Exceeds ENERGY STAR® standards (U-Factor - 0.29, SHGC - 0.22)
- Cam locks with keepers fastened into reinforcements provide security and reduced air infiltration
- Dual locks on widths 24" and above
- 3/4" Cardinal IG glass with argon standard; silver glass coat beats tints for solar, heat and humidity control
- 3/4" Extruded Integral J-Channel design; 2-7/8" jamb
- Continuous reinforcement in fixed meeting rail for structural integrity
- Positive interlock for increased security and less air infiltration
- Tilt-in lower sash for easy cleaning
- Positive sloped sill for water runoff
- Bulb seal at bottom of lower sash permits tight fit between sash and frame
- Inverted block and tackle balances for smooth operation
- Extruded sash lift rail for easy operation
- 1-1/4" extruded nail-fin with 1" set back
- Protected by Preserve® glass film for scratch resistance and quick glass clean up
- DP-50 Rating Optional

Internal Grid Options



3/4" Flat



5/8" Sculptured



Exterior grids - 7/8 SDL w/ GIA

Designer Color Choices



White PVC Standard



Beige PVC Optional



Gray PVC Optional

Optional Exterior/Interior Laminate
Black exterior on White interior



SHOWCASE
windows and doors

1702 Cullen Blvd. • Houston, Texas • 77023
Phone: 713-926-8500
Fax: 713-926-8484
www.showcasewindows.com
sales@showcasewindows.com



30019.02





WINDOWS

STANDARD COLORS

VINYL/EXTRUDED COLORS



White



Almond



Clay

UPGRADE COLORS

\$1,800 UPGRADE STARTING PRICE

BLACK

40% MORE THAN STANDARD – TYPICALLY

**WHITE ON INSIDE

MIXING WINDOW COLORS

\$500 UPGRADE



EXTERIOR DOORS

EXTERIOR DOOR TYPE: 8 FT, SINGLE LIGHT.

INCLUDED - BUILT-IN BLINDS FOR ONE (1) EXTERIOR DOOR.

UPGRADE EACH ADDITIONAL DOOR - BUILT-IN BLINDS
UPGRADE EACH ADDITIONAL DOOR - IF BUILT-IN BLINDS ARE INSTALLED AFTER
DOOR IS INSTALLED.





ROOFING



Oakridge® Shingles

Make it your own.

When does a house become a home? When the place you live in begins to reflect the life you're living. When every change, both big and small, makes it more and more your own. Choosing a new roof is your opportunity to make a major impact on the look of your home — and we're here to help. Owens Corning has been a leader in the building materials industry for over 75 years. So you can be confident that your new roof will enhance and help protect your home for years to come.

The Right Choice®

Oakridge® Shingles are The Right Choice® for long-lasting performance and striking beauty. In addition to a wide range of inviting, popular colors, they also offer:

- Limited Lifetime Warranty*† (for as long as you own your home)
- 110/130** MPH Wind Resistance Limited Warranty*
- StreakGuard™ Protection with a 10-year Algae Resistance Limited Warranty.*

ENERGY STAR® is for roofs too.

Similar to the energy-efficient appliances in your home, roofing products can help provide energy-saving qualities. Owens Corning® Oakridge® Roofing Shingles in Shasta White can help reduce your heating and cooling bills when installed properly.

These shingles reflect solar energy, helping to decrease the amount of heat transferred to a home's interior — and the amount of air conditioning needed to keep it comfortable. Actual savings will vary based on geographic location and individual building characteristics. Call 1-800-GET-PINK® or 1-888-STAR-YES for more information.

Product Attributes

Warranty Length*
Limited Lifetime* (for as long as you own your home)

Wind Resistance Limited Warranty*
110/130** MPH

Algae Resistance Limited Warranty*
10 Years

TRU PROtection® Non-Prorated Limited Warranty* Period
10 Years

Product Specifications

Nominal Size	13 1/4" x 39 3/4"
Exposure	5 1/2"
Shingles per Square	64
Bundles per Square	3
Coverage per Square	98.4 sq. ft.

Applicable Standards and Codes

ASTM D228
ASTM D3018 (Type 1)
ASTM D3161 (Class F Wind Resistance)
ASTM D3462
ASTM D7158 (Class H Wind Resistance)
ASTM E108/UL 790 (Class A Fire Resistance)
ICC-ES AC408®
PRI ER 1378E01

Shasta White color meets ENERGY STAR® requirements for initial solar reflectance of 0.29 and 3-year aged solar reflectance of 0.15; 2013 California Building Energy Efficiency Standards, Title 24, Part 6 requirements; rated by the Cool Roof Rating Council (CRRCC).



ROOFING

Oakridge® Color Availability



Amber†
Not Available in Service Area 11 (see map).



Brownwood†



Desert Tan†



Driftwood†



Estate Gray†



Onyx Black†



Shasta White†



Sierra Gray†
Not Available in Service Area 11 (see map).

ROOFING



Aged Cedar†



Flagstone†



Peppermill Gray†



Teak†

METAL ROOF AND AWNINGS

QUOTED UPGRADE - PRIOR TO CONSTRUCTION



The Southwest Leader in Panelized Residential Steel Roofing

www.metalmarts.com

Ultra-Prime™ Kynar 500® Colors

GALVALUME® substrate with Kynar 500® coating

40 Year Limited Finish Warranty

 REGAL WHITE†	 LIGHT STONE†	 ASH GRAY†
 IVORY†	 SURREY BEIGE†	 CHARCOAL†
 ROMAN BLUE†	 CLAY†	 PATRICIAN BRONZE†
 EVERGREEN†	 TUDOR BROWN*†	 AUTUMN RED†

Siliconized Polyester Colors

GALVALUME® substrate with Weather X coating

30 Year Limited Finish Warranty

 AUTUMN RED†	 BRITE WHITE†	 LIGHT STONE†
 EVERGREEN†	 TIMBER TAN†	 ASH GRAY†
 GALVALUME PLUS 20 Year Limited Warranty		

* TUDOR BROWN available in Kynar & Siliconized Polyester

† Meets Energy Star requirements for Cool Roofing

Kynar 500® is a registered Trademark of ELF Atochem N.A. Inc.

Galvalume® is a registered Trademark of BIEC International, Inc.

Actual paint color may be slightly different than color indicated on this chart.



PORCH CEILING

INCLUDED - HARDIE SOFFIT



PORCH CEILING

QUOTE UPGRADE - 1X6 TONGUE AND GROOVE

MUST BE SELECTED PRIOR TO CONSTRUCTION AND DESIGN MEETING



STONE SELECTION

MUST GO TO: BROOKS STONE RANCH

(830) 624-7554

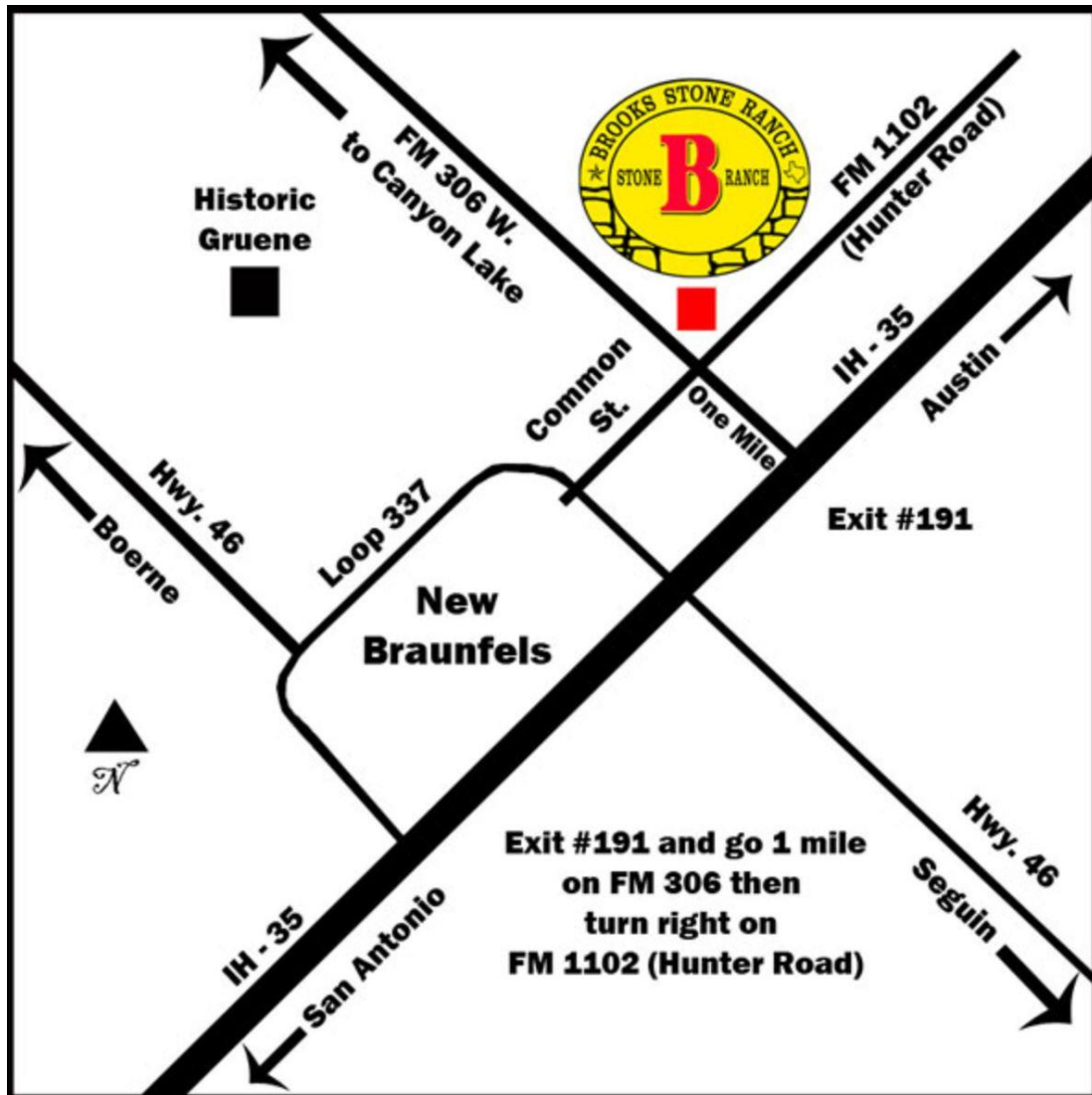

Take IH-35 Exit 191-Canyon Lake

We're at the Corner of FM 306 (Canyon Lake Road) &

E. Common St. (Hunter Rd.) (2051 FM 1102)

New Braunfels, TX (Near Historic Gruene)





PAINT SELECTIONS

EXTERIOR

MAY CHOOSE TWO (2) COLORS FROM SHERWIN-WILLIAMS.

- **COLOR 1:** (BODY OF HOUSE), (SOFFIT), AND (GARAGE DOOR COLOR)
- **COLOR 2:** TRIM COLOR (WINDOW TRIM), (FASCIA), AND (CORNERS)

ANY CEDAR ACCENTS WILL BE STAINED A SEPARATE COLOR OF YOUR CHOICE FROM SHERWIN WILLIAMS.

STARTING PRICE UPGRADE - ADDING AN ADDITIONAL PAINT COLOR. (1,600 – 1,700 SQ.FT.)

WHITE COLORS NEED TWO COATS AND IS SUBJECT TO HIGHER PRICES.

INTERIOR

MAY CHOOSE THREE (3) COLORS FROM SHERWIN-WILLIAMS OR PPG.

INCLUDED - CELINGS ARE ALWAYS SHERWIN WILLIAMS, **PURE WHITE (FLAT)**.

COLOR 1: WALL (**FLAT**)

COLOR 2: TRIM AND INTERIOR DOOR COLOR (**GLOSS**)

COLOR 3: CABINET PAINT COLOR OR STAIN COLOR. (**GLOSS**)

UPGRADE FOR ADDITIONAL ISLAND COLOR OR STAIN.

UPGRADE PER ROOM FOR AN ADDITIONAL COLOR FOR WALLS.

UPGRADE FOR AN ADDITIONAL COLOR FOR CEILING

UPGRADE EGGSHELL OR SATIN (SQUARE FOOTAGE OF HOME DIVIDED BY 2. (EXAMPLE: 1,600 SQUARE FOOT HOME WOULD BE \$800 UPGRADE; FOR WALLS ONLY)

UPGRADE FOR INTERIOR DOORS PAINTED A COLOR OTHER THAN TRIM.



FIREPLACE

Element wood-burning fireplaces

Traditional Style *Proven Value*

Add traditional style and ambiance to your favorite space with the Heatilator Element. A detailed brick interior creates the look of classic masonry at a fraction of the cost. And, all you see is fire—a clean finish with true 36- and 42-inch viewing areas deliver maximum impact.

Experience proven value and dependability from Heatilator. Experience the Element.

Features

- 36" or 42" viewing areas
- Bi-fold glass doors available with multiple trim options
- Convenient ash lip
- User-friendly front damper handle locks in open/closed positions
- A hearth extension is required

Options (Shown Right)

- Bi-fold glass doors
- Fireside gas logs



Cover/Above: Element shown with fairfield mantel, green granite and bi-fold glass doors

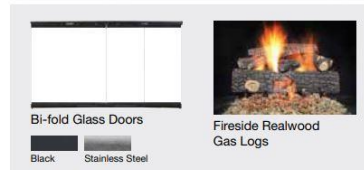

Dimensions

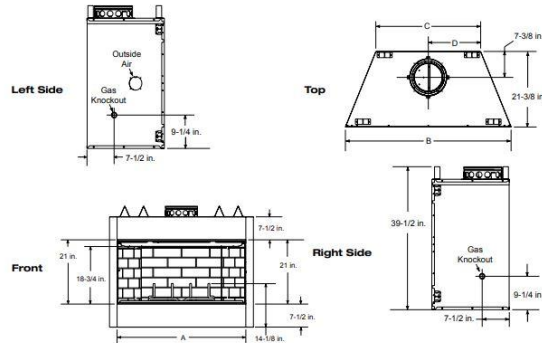

MODEL	A	B	C	D
EL36	36"	41"	23-3/4"	11-7/8"
EL42	42"	47"	29-3/4"	14-7/8"

Framing Dimensions

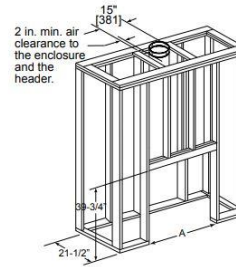

MODEL	A
EL36	42"
EL42	48"

Available From

heatilator
The first name in fireplaces

Phone: 800-927-6841

Web: heatilator.com

[facebook.com/Heatilator](https://www.facebook.com/Heatilator)

twitter.com/Heatilator

[youtube.com/HeatilatorFireplaces](https://www.youtube.com/HeatilatorFireplaces)

 HTL-1020U-0915

Limited Lifetime Warranty*

The strongest in the industry, Heatilator provides a limited lifetime warranty on wood-burning products of the most important aspects: firebox and heat exchanger.

*For full warranty details go to heatilator.com.

The information provided in this literature is for planning purposes only and subject to change. Please consult the installation manual for actual installation. Actual product appearance may differ from product images.

Fireplace glass and other surfaces get extremely HOT and can cause severe burns if touched. Do not remove the protective safety screen from the front of the glass. Keep a safe distance away. To learn more visit www.heatilator.com/fireplacesafety

INCLUDED - 42" WOOD BURNING FIREPLACE

UPGRADE – FIREPLACE ONLY. GAS BURNING, STARTER.

GLASS AND FIRESIDE GAS LOGS CAN BE PURCHASED AND PROFESSIONALLY INSTALLED AFTER CLOSING FROM PARRISH & CO.

UPGRADE – FOR ANY DIFFERING FIREPLACE. DOES NOT INCLUDE FIREPLACE, WIRING, PLUMBING OR INSTALLATION.



FIREPLACE ROCK



INCLUDED – FIREPLACE AND MANTLE CONFIGURATION.
APPROXIMATELY 56" TALL.

TYPICAL – WRAP STONE TO SIDES.



FIREPLACE ROCK



**OPTIONAL – STONE ON FRONT ONLY, NOT ON SIDES (SHEETROCK SIDES)
(FOR USE WITH FURNITURE ON THE SIDES.)**



FIREPLACE ROCK



INCLUDED - CORNER FIREPLACE CONFIGURATION.

APPROXIMATELY 56" TALL.



FIREPLACE ROCK



UPGRADE - RAISED FIREPLACE AND ROCK HEARTH



FIREPLACE ROCK



**UPGRADE – INSTALL ONLY, RAISED FIREPLACE AND SLAB HEARTH
DOES NOT INCLUDE PURCHASE OF SLAB / SLAB: 2-1/4”Tx40”Wx24”D**



FIREPLACE ROCK



UPGRADE – ROCK TO CEILING AND ROCK MANTLE



FIREPLACE ROCK



UPGRADE – ROCK TO CEILING AND ROCK MANTLE



FIREPLACE MANTLE



UPGRADE - COLONIAL MANTLE



UPGRADE - MODERN MANTLE

UPGRADE - ROCK TO CEILING

UPGRADE - ROCK TO CEILING

DIMENSIONS

12”T x 12”D x length of fireplace

***LIVE EDGE MANTLE MUST BE QUOTED AND DISCUSSED PRIOR TO FRAMING**



CABINETS



Shaker



Raised Panel

DOOR TYPE

1. SHAKER
2. RAISED PANEL

WOOD TYPE

1. STAIN GRADE (KNOTTY ALDER)
2. PAINT GRADE (POPLAR)

INCLUDED

- UPPER CABINETS ARE 42" TALL.
- LOWERS ARE 36" TALL
- SOFT CLOSE CABINET DOORS, ONLY

HOMEOWNER HAS THE OPPORTUNITY TO DESIGN CABINET LAYOUT. A PDF OF THE CABINET PLAN WILL BE EMAILED TO THE HOMEOWNER AFTER FRAMING. THE HOMEOWNER CAN MAKE CHANGES THAT INCLUDE (BUT NOT LIMITED TO):

ALL SUBJECT TO COST UPGRADES

/PER DRAWER - SOFT CLOSE DRAWERS

- TRASH CAN PULL OUT
- ADDING DRAWERS IN PLACE OF CABINETS
- ADDING FINGER GROOVES IN PLACE OF CABINET HARDWARE
- ADDING GLASS INSERTS
- SELECTING A HOOD STYLE
- EXTENDING CABINETS TO CEILING



CABINETS

ANGULAR VENT-A-HOOD



UPGRADE – 30" ANGULAR HOOD - WOOD WORK ONLY

UPGRADE – SIDE FURRS

UPGRADE – SIDE CORBELS

REQUIRES UPGRADE – APPLIANCE BLOWER MOTOR AND LINER

REF. APPLICANCES FOR PRICING



CABINETS

SQUARE VENT-A-HOOD



UPGRADE – 30" STRAIGHT HOOD - WOOD WORK ONLY

***REQUIRES UPGRADE – APPLIANCE BLOWER MOTOR AND LINER*
REF. APPLICANCES FOR PRICING**



CABINETS

KITCHEN ISLAND



INCLUDED - ISLAND – 36" TALL



UPGRADE - RAISED KITCHEN ISLAND – 36"/42" TALL

INTERIOR DOORS



SQUARE RAISED PANEL



CHEYENNE ARCH TOP



5-SQUARE PANEL

TYPICAL 6'8" TALL



INTERIOR DOORS

BARN DOORS



SLADE



SLADE SS



GILA 12"



METRO 12"



CRAFTSMAN



2-PANEL



5-PANEL SQUARE



INTERIOR DOORS

BARN DOORS



PLANK KNOTTY ALDER

(DOOR COMES UNFINISHED – FINISHED ON JOBSITE)

NOTE: 8' TALL DOOR REQUIRED FOR BARN DOOR.

DOOR OPENING IS 6'8" TALL.

**DOOR MUST BE QUOTED AND PRE-PLANNED PRIOR
TO FOUNDATION POUR**



INTERIOR TRIM

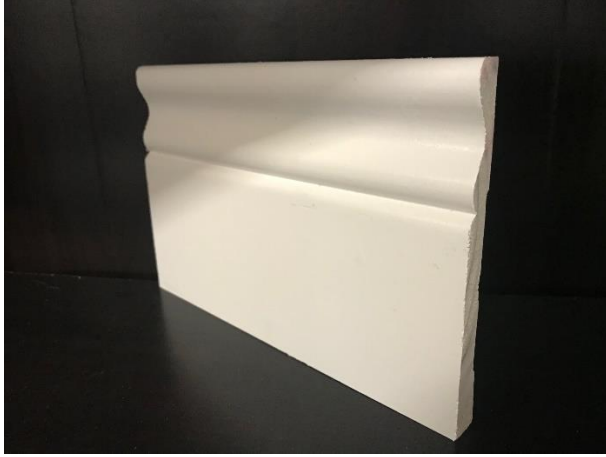

COLONIAL
5-1/4" BASEBOARD



CRAFTSMAN
5-1/2" BASEBOARD

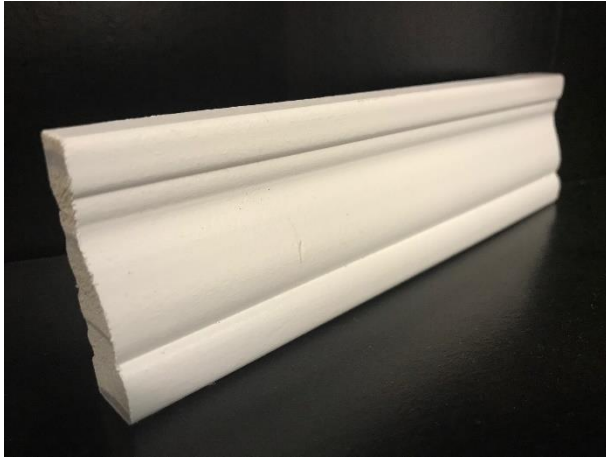

COLONIAL
2-1/8" WINDOW TRIM



CRAFTSMAN
3-1/2" WINDOW TRIM

INTERIOR DOOR HARDWARE

LEVEL 1 INCLUDED



TUSTIN (TYPICAL)



POLO

IRON BLACK NOT AVAILABLE

INCLUDED HANDLE FINISHES



*Venetian
Bronze 11P*



*Satin
Nickel 15*

UPGRADE - HANDLE FINISHES



*Antique
Nickel 15A*



*Polished
Chrome 26*



*Satin
Chrome 26D*



*Iron
Black 514*

IRON BLACK ONLY AVAILABLE ON TUSTIN



INTERIOR DOOR HARDWARE

LEVEL 2 UPGRADE



DORIAN



HANCOCK

(AVAILABLE IN MATTE BLACK)

(ADDITIONAL UPGRADE)



LIDO



LADERA

LEVEL 2 HANDLE FINISHES



*Venetian
Bronze* 11P



*Satin
Nickel* 15



*Antique
Nickel* 15A



*Polished
Chrome* 26



*Satin
Chrome* 26D



INTERIOR DOOR HARDWARE

LEVEL 3 **UPGRADE**



HALIFAX



LAUREL

LEVEL 3 INCLUDED HANDLE FINISHES



11P
Venetian
Bronze



15
Satin
Nickel



26
Polished
Chrome



26D
Brushed
Chrome



514
Iron
Black



FRONT DOORS

CRAFTSMAN 6 LITE MAHOGANY & ALDER 8'0" Tall



ESTANCIA KNOTTY ALDER
36" DOOR 3'0" X 8'0"
INCLUDES DENTIL SHELF

DOORCRAFT MAHOGANY
36" DOOR 3'0" X 8'0"
INCLUDES DENTIL SHELF

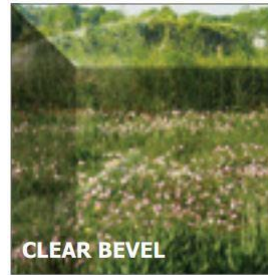

2 - PRIVACY RATING

CLEAR BEVEL ONLY



FRONT DOORS

6 LITE TDL MAHOGANY & ALDER DOOR 8'0" TALL

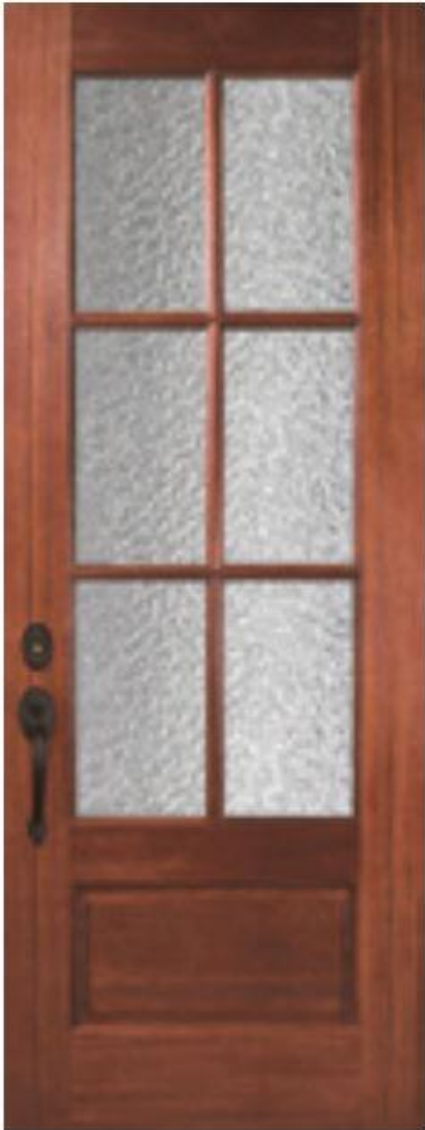

ESTANCIA KNOTTY ALDER
36" DOOR 3'0" X 8'0"

DOORCRAFT MAHOGANY
36" DOOR 3'0" X 8'0"



FRONT DOORS

MAHOGANY BUNGALOW 4 LITE TDL DOOR 8'0" TALL



PORTOBELLO MAHOGANY
36" DOOR 3'0" X 8'0"



Water texture



Rain texture



Clear Bevel texture

FRONT DOORS

2 PANEL ESTANCIA KNOTTY ALDER DOOR 8'0" TALL



ESTANCIA KNOTTY ALDER
36" DOOR 3'0" X 8'0"
SHOWN AS:
SPEAK EASY
V-GROOVES
METAL CLAVOS



ESTANCIA KNOTTY ALDER
36" DOOR 3'0" X 8'0"
SHOWN AS:
2 PANEL ARCH

FRONT DOORS

2 PANEL MAHOGANY DOOR 8'0" TALL



DOORCRAFT MAHOGANY
36" DOOR 3'0" X 8'0"
SHOWN AS:
SPEAK EASY
V-GROOVE
METAL CLAVOS



DOORCRAFT MAHOGANY
36" DOOR 3'0" X 8'0"
SHOWN AS:
2 PANEL
V-GROOVE

FRONT DOORS

2-PANEL ESTANCIA ALDER & MAHOGANY DOOR 8'0" TALL

OPTIONS
V-GROOVE
NON V-GROOVE

UPGRADE - METAL CLAVOS

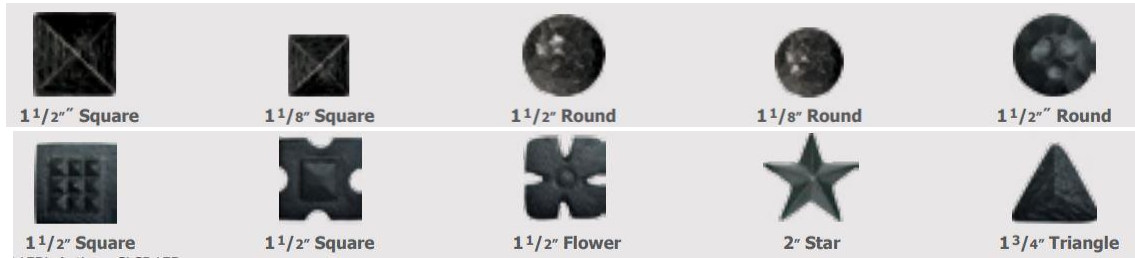

SPEAK EASY GRILLE OPTION

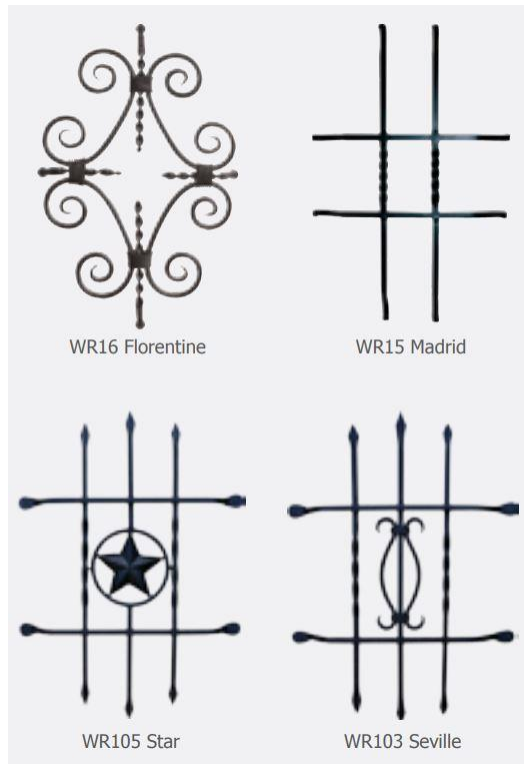

FRONT DOORS

2-PANEL ESTANCIA ALDER & MAHOGANY DOOR 8'0" TALL

OPTIONS

SPEAK EASY GLASS OPTIONS



1 - PRIVACY RATING



3 - PRIVACY RATING

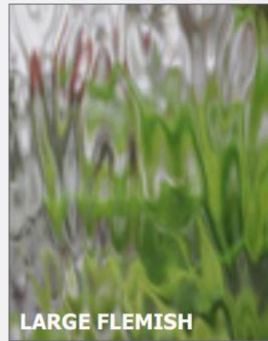

5 - PRIVACY RATING



7 - PRIVACY RATING



7 - PRIVACY RATING



8 - PRIVACY RATING

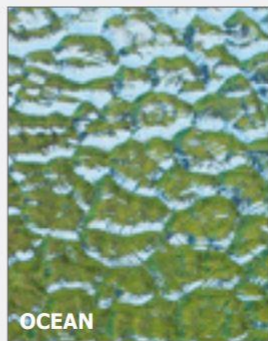

8 - PRIVACY RATING



9 - PRIVACY RATING



FRONT DOORS

SANTA MONICA MAHOGANY 8'0" TALL

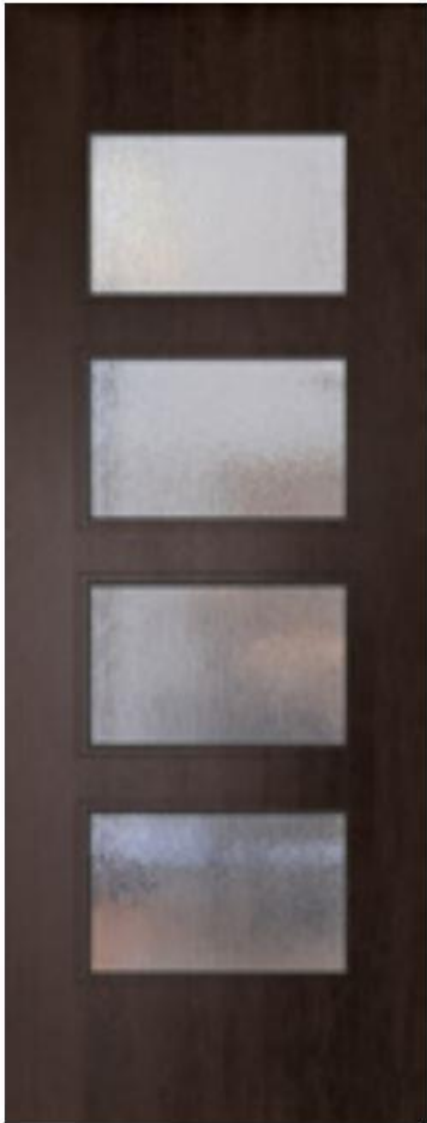

SANTA MONICA MAHOGANY
36" DOOR 3'0" X 8'0"
SHOWN AS: RAIN GLASS TEXTURE

GLASS OPTIONS

CLEAR
RAIN
REEDS
WATER



FRONT DOOR HARDWARE

INCLUDED LEVEL 1



CHELSEA

DAKOTA

ARLINGTON

LEVEL 1 FRONT DOOR HARDWARE FINISH



*Venetian
Bronze 11P*



*Satin
Nickel 15*



FRONT DOOR HARDWARE

LEVEL 2 **UPGRADE**



AMHERST



TAVARIS

LEVEL 2 FINISHES



*Venetian
Bronze 11P*



*Satin
Nickel 15*



FRONT DOOR HARDWARE

LEVEL 3

UPGRADE



AVALON



HAWTHORNE



*Venetian
Bronze* 11P



*Satin
Nickel* 15



514
Iron
Black





GARAGE DOOR

INCLUDED - ACCORDING TO PLAN

- 16'X8'
- OR
- **DOUBLE 8'X8'**
- BEAD BOARD
- SINGLE-LAYER STEEL
- STAMPED STEEL BLUE RIDGE HARDWARE
- PAINTED TO MATCH HOUSE
- ONE (1) KEYLESS ENTRY PAD
- ONE (1) OR TWO (2) MOTORS

DOOR UPGRADES

- 16'X8' PANEL DESIGN OTHER THAN BEAD BOARD
- 16'X8' VINYL BACK INSULATED
- 16'X8' WOOD LOOK
- 16'X8' ADD GLASS
- 16'X8' NO DOOR HARDWARE
- 16'X8' BLACK OR CHARCOAL

(X1) - 8'X8' PANEL DESIGN OTHER THAN BEAD BOARD

(X1) - 8'X8' VINYL BACK INSULATED

(X1) - 8'X8' WOOD LOOK

(X1) - 8'X8' ADD GLASS

(X1) - 8'X8' NO DOOR HARDWARE

(X1) - 8'X8' BLACK OR CHARCOAL

(X2) - FOR HOUSES WITH DOUBLE DOORS

OPENERS

ALL OPENERS HAVE BUILT-IN WI-FI

INCLUDED – ACCORDING TO PLAN

LIFTMASTER ½ HP BELT OR X2 FOR DOUBLE 8'X8' DOORS

INCLUDED - KEYPAD MOUNTED OUTSIDE GARAGE DOOR

MOTOR UPGRADES

- *LIFTMASTER ½ HP PREMIUM

- *LIFTMASTER ¾ HP DC BELT ELITE

+ADDITIONAL COST FOR TRIM - *LIFTMASTER 8500W JACKSHAFT -

*UPGRADING MOTORS ARE SUBJECT TO COMPATABILITY WITH DOOR



GARAGE DOOR

Construction

HI1000

Single-Layer: Steel

- Heavy-duty Exterior Steel
- Durable, Reliable, Low Maintenance



HI2000

Double-Layer: Steel + Insulation

- Heavy-duty Exterior Steel
- Durable, Reliable, Low Maintenance
- Environmentally Safe Polystyrene Thermal Insulation with Vinyl Backing
- Energy Efficient
- Quiet Operation



Specifications

	HI1000	HI2000
PANEL DESIGNS		
Bead Board	•	•
Long Bead Board	•	•
Recessed	•	•
Raised	•	•
INSULATION¹		Polystyrene
R-VALUE²		6.64
DOOR THICKNESS	2" (5.1cm)	2" (5.1cm)
STEEL THICKNESS	25 ga	25 ga

GARAGE DOOR

INCLUDED – BEAD BOARD WITH HARDWARE (NON-INSULATED)



UPGRADES

LONG BEAD BOARD WITH HARDWARE



GARAGE DOOR

UPGRADES CONTINUED RAISED PANEL WITH HARDWARE



RECESSED WITH HARDWARE



GARAGE DOOR

UPGRADES CONTINUED

Glass Options

Insulated glass available in Clear, Frost and Dark Tint.

CLEAR (C)



3/32" (0.24cm) Single Strength

OBSCURE (O)*



FROST (WF)*



DARK TINT (WD)*



*Price upcharge applies.

DecraTrim Window Inserts

Available with Clear, Obscure, Frost or Dark Tint glass.

NO INSERT



STOCKTON (20)



PRAIRIE (21)



CATHEDRAL (22)



CASCADE (23)



MOONLITE (24)



WATERFORD (25)



WAGON WHEEL (26)



SUNRAY (27)



THAMES (30)



ARCHED THAMES (31)



FULL SUNRAY (28) Available for 15'6", 15'8", 16', 17' and 18' only.



GARAGE DOORS

UPGRADES CONTINUED

GOLDEN OAK WITH HARDWARE



WALNUT WITH HARDWARE

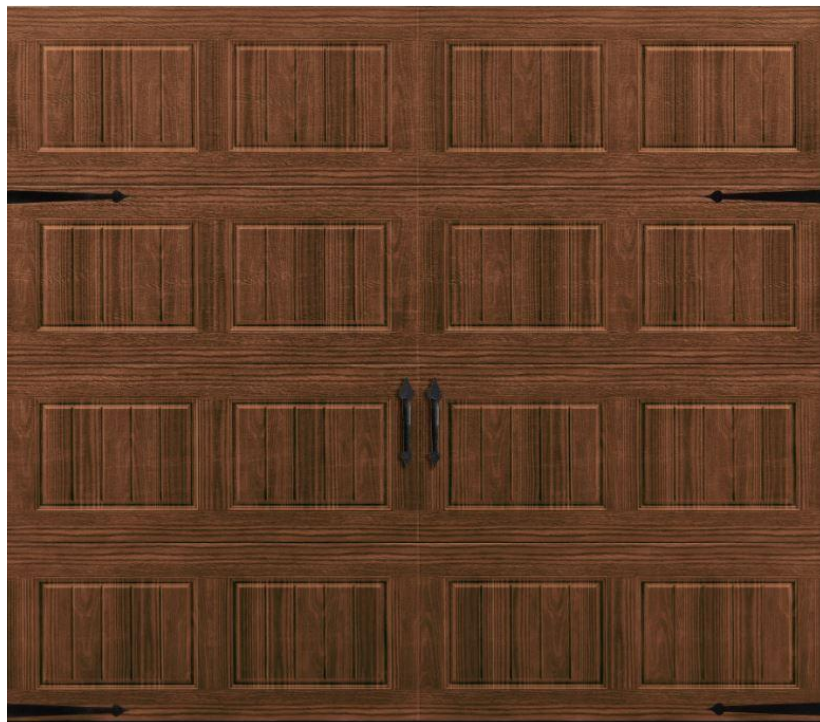



GARAGE DOORS

UPGRADES CONTINUED

MAHOGANY WITH HARDWARE





FLOORING / TILE

FLOOR TILE – ONE (1) TILE TYPE ON FLOOR

INCLUDED: LEVEL 2

UPGRADES: MUST BE PAID FOR PRIOR TO ORDER AND INSTALL

UPGRADE: LEVELING SYSTEM
-TYPICAL 1/16" SPACING
-REQUIRED FOR TILE OVER 24"
-SQUARE EDGE ON TILE

FLOOR PATTERNS MUST BE QUOTED

BATH WALL TILE

INCLUDED: LEVEL 3

UPGRADE: MUST BE PAID FOR PRIOR TO ORDER AND INSTALL

UPGRADE: NICHE **UPGRADE EACH** AND MUST BE PLANNED PRIOR TO FOUNDATION POUR. ROUGHLY 14"X14" STANDARD. WALL TILE IN BACKGROUND IS STANDARD.

NOTE: TWO (2) SHELFs INCLUDED IN TUB/SHOWER COMBO.
ONE (1) SHELF INCLUDED IN MASTER SHOWER.
CORNER SEATS ARE STANDARD IN SHOWERS.

UPGRADE: SHELF **EACH**.
LONG SEAT
DECO TILE IN BACKGROUND OF NICHE
TILE PICTURE FRAMES **MUST BE QUOTED**.

PLANS MAY INDICATED LONG BENCH, BUT CORNER BENCHES ARE STANDARD.





FLOORING / TILE

WOOD

UPGRADE

UNDERLAYMENT TYPE AND GRADE

TRANSITIONS

SHOE-MOULDING

CARPET

LEVEL 1 INCLUDED

LEVEL 2 INCLUDED

UPGRADE LEVEL 3

STAINED CONCRETE - ***MUST KNOW PRIOR TO FOUNDATION POUR***

LEVEL 2 INCLUDED

SAMPLES ARE CONDUCTED AT HOME UNDER CABINETS.

NO DESIGNS OR WOOD LOOK OFFERED.

DESIGN FEE IS REQUIRED WHEN SELECTING STAINED CONCRETE



PLUMBING FIXTURES

**** MOEN PRODUCTS ONLY****

BATHROOM FAUCETS

INCLUDED - LEVEL 1 - 4-INCH SPREAD



BRANTFORD (BRUSHED NICKEL)



BRANTFORD (ORB)



EVA (BRUSHED NICKEL)



EVA (ORB)



PLUMBING FIXTURES

**** MOEN PRODUCTS ONLY****

BATHROOM FAUCETS

INCLUDED - LEVEL 1 – 4-INCH SPREAD



GIBSON (MATTE BLACK)



GLYDE (MATTE BLACK)

PLUMBING FIXTURES

**** MOEN PRODUCTS ONLY****

BATHROOM FAUCETS

UPGRADE PER FIXTURE – LEVEL 1 WITH 8-INCH SPREAD



BRANTFORD (BRUSHED NICKEL)



BRANTFORD (ORB)



EVA (BRUSHED NICKEL)



EVA (ORB)

PLUMBING FIXTURES

**** MOEN PRODUCTS ONLY****

BATHROOM FAUCETS

UPGRADE PER FIXTURE – LEVEL 2 – 4-INCH SPREAD



DARTMOOR (BRUSHED NICKEL) 4"



DARTMOOR (ORB) 4"



VOSS (BRUSHED NICKEL) 4"



VOSS (ORB) 4"



ALIGN (BRUSHED NICKEL)



ALIGN (MATTE BLACK)

PLUMBING FIXTURES

**** MOEN PRODUCTS ONLY****

BATHROOM FAUCETS

UPGRADE PER FIXTURE – LEVEL 2 – 8-INCH SPREAD OR HIGH ARC



DARTMOOR (BRUSHED NICKEL) 8"



DARTMOOR (ORB) 8"



VOSS (BRUSHED NICKEL) 8"



VOSS (ORB) 8"



ALIGN (BRUSHED NICKEL) HIGH ARC



ALIGN (MATTE BLACK) HIGH ARC

PLUMBING FIXTURES

**** MOEN PRODUCTS ONLY****

BATHROOM FAUCETS

UPGRADE PER FIXTURE – LEVEL 3 – 4-INCH SPREAD OR SINGLE HOLE



ALIGN (BRUSHED GOLD)



ALIGN (CHROME)



VOSS (BRUSHED GOLD)

PLUMBING FIXTURES

**** MOEN PRODUCTS ONLY****

BATHROOM FAUCETS

UPGRADE PER FIXTURE – LEVEL 4 – SINGLE HOLE



WEYMOUTH (CHROME) SINGLE HANDLE

PLUMBING FIXTURES

**** MOEN PRODUCTS ONLY****

BATHROOM FAUCETS

UPGRADE PER FIXTURE – LEVEL 4 – SINGLE HOLE (UPGRADE FINISHES)



WEYMOUTH (ORB) SINGLE HOLE



WEYMOUTH (BN) SINGLE HOLE



WEYMOUTH (BLACK) SINGLE HOLE



WEYMOUTH (BG) SINGLE HOLE

PLUMBING FIXTURES

**** MOEN PRODUCTS ONLY****

BATHROOM FAUCETS

UPGRADE PER FIXTURE – LEVEL 4 – 8 IN SPREAD



WEYMOUTH (CH) 8IN



WEYMOUTH (ORB) 8IN



WEYMOUTH (BN) 8IN



WEYMOUTH (MB) 8IN



WEYMOUTH (BG) 8IN

PLUMBING FIXTURES

****** MOEN PRODUCTS ONLY******

KITCHEN FAUCET

LEVEL 1



BRANTFORD (BN)



BRANTFORD (ORB)



ARBOR (BN) GOES WITH EVA BATH



ARBOR (ORB) GOES WITH EVA



PLUMBING FIXTURES

****** MOEN PRODUCTS ONLY******

KITCHEN FAUCET

LEVEL 1



SLEEK (MATTE BLACK)



PLUMBING FIXTURES

****** MOEN PRODUCTS ONLY******

KITCHEN FAUCET

LEVEL 2 UPGRADE



ALIGN (BN)



ALIGN (CH)



ALIGN (ORB)



WEYMOUTH (BN)



WEYMOUTH (CH)



WEYMOUTH (ORB)



PLUMBING FIXTURES

****** MOEN PRODUCTS ONLY******

KITCHEN FAUCET

LEVEL 3 UPGRADE



ALIGN S (BN)



ALIGN S (MB)



ALIGN S (BSS)



ALIGN S (CH)



ALIGN (BG)



WEYMOUTH (BG)



PLUMBING FIXTURES

****** MOEN PRODUCTS ONLY******

TUB – SHOWER COMBO

LEVEL 1 - INCLUDED **BRANTFORD AND EVA**

UPGRADE - TO ADD A LARGE HEAD



EVA AND BRANTFORD LARGE
(BN) AND (ORB)



BRANTFORD (BN)

BRANTFORD (ORB)



EVA (BN)

EVA (ORB)



PLUMBING FIXTURES

****** MOEN PRODUCTS ONLY******

TUB – SHOWER COMBO

LEVEL 1 - INCLUDED **GIBSON AND GLYDE**



GIBSON (MATTE BLACK)

GLYDE (MATTE BLACK)



PLUMBING FIXTURES

****** MOEN PRODUCTS ONLY******

TUB – SHOWER COMBO

LEVEL 2 UPGRADE PER FIXTURE DARTMOOR, KINGSLEY AND ALIGN



DARTMOOR (BN)

DARTMOOR (ORB)



KINGSLEY (BN)

KINGSLEY (ORB)



PLUMBING FIXTURES

****** MOEN PRODUCTS ONLY******

TUB – SHOWER COMBO

LEVEL 2 UPGRADE PER FIXTURE DARTMOOR, KINGSLEY AND ALIGN



ALIGN (BN)

ALIGN (MB)

PLUMBING FIXTURES

****** MOEN PRODUCTS ONLY******

TUB – SHOWER COMBO

LEVEL 3 UPGRADE PER FIXTURE ALIGN, GLYDE, AND VOSS



ALIGN (BG)



ALIGN (CH)



VOSS (MB)



PLUMBING FIXTURES

****** MOEN PRODUCTS ONLY******

TUB – SHOWER COMBO

LEVEL 3 UPGRADE PER FIXTURE ALIGN, GLYDE, AND VOSS



GLYDE (BG)



GLYDE (BN)



GLYDE (ORB)

PLUMBING FIXTURES

****** MOEN PRODUCTS ONLY******

TUB – SHOWER COMBO

LEVEL 4 UPGRADE PER FIXTURE WEYMOUTH



WEYMOUTH (BN)



WEYMOUTH (CH)



WEYMOUTH (ORB)



WEYMOUTH (MB)



WEYMOUTH (BG)

PLUMBING FIXTURES

****** MOEN PRODUCTS ONLY******

SHOWER

LEVEL 1 INCLUDED



BRANTFORD (BN)

BRANTFORD (CH)

BRANTFORD (ORB)



EVA (BN)

EVA (CH)

EVA (ORB)



PLUMBING FIXTURES

****** MOEN PRODUCTS ONLY******

SHOWER

LEVEL 1 INCLUDED



GIBSON (MATTE BLACK)



GLYDE (MATTE BLACK)



PLUMBING FIXTURES

****** MOEN PRODUCTS ONLY******

SHOWER

LEVEL 2 UPGRADE PER FIXTURE KINGSLEY AND ALIGN



KINGSLEY (BN)

KINGSLEY (CH)

KINGSLEY (ORB)



ALIGN (BN)

ALIGN (CH)

ALIGN (MB)



PLUMBING FIXTURES

****** MOEN PRODUCTS ONLY******

SHOWER

LEVEL 3 UPGRADE PER FIXTURE VOSS AND DARTMOOR



VOSS (BN)



VOSS (CH)



VOSS (ORB)



DARTMOOR (BN)



DARTMOOR (CH)



DARTMOOR (ORB)



PLUMBING FIXTURES

****** MOEN PRODUCTS ONLY******

SHOWER

LEVEL 4 UPGRADE PER FIXTURE ALIGN, VOSS, AND WEYMOUTH



ALIGN (BG)



VOSS (BG)



WEYMOUTH (BG)



PLUMBING FIXTURES

****** MOEN PRODUCTS ONLY******

SHOWER

LEVEL 4 UPGRADE PER FIXTURE ALIGN, VOSS, AND WEYMOUTH



WEYMOUTH (BN)



WEYMOUTH (CH)



WEYMOUTH (MB)



WEYMOUTH (ORB)



PLUMBING FIXTURES

****** MOEN PRODUCTS ONLY******

HANDHELD SHOWER UPGRADE PER FIXTURE



BRUSHED NICKEL



CHROME



OIL RUBBED BRONZE

PLUMBING FIXTURES

****** MOEN PRODUCTS ONLY******

HANDHELD SHOWER MOUNTED ON BAR

UPGRADE PER FIXTURE



BN



CH



MB



ORB



PLUMBING FIXTURES

****** MOEN PRODUCTS ONLY******

TUB FILLERS

LEVEL 1



BRANTFORD (BN)



BRANTFORD (CH)



BRANTFORD (ORB)

PLUMBING FIXTURES

****** MOEN PRODUCTS ONLY******

TUB FILLERS

LEVEL 1



EVA (BN)



EVA (CH)



EVA (ORB)



PLUMBING FIXTURES

****** MOEN PRODUCTS ONLY******

TUB FILLERS

LEVEL 1



GIBSON (MATTE BLACK)



GLYDE (MATTE BLACK)



PLUMBING FIXTURES

****** MOEN PRODUCTS ONLY******

TUB FILLERS LEVEL 2 UPGRADE DARTMOOR



DARTMOOR (BN)



DARTMOOR (CH)



DARTMOOR (ORB)



PLUMBING FIXTURES

****** MOEN PRODUCTS ONLY******

TUB FILLERS LEVEL 3 UPGRADE PER FIXTURE VOSS AND ALIGN



VOSS (BN)



VOSS (CH)



VOSS (ORB)

PLUMBING FIXTURES

****** MOEN PRODUCTS ONLY******

TUB FILLERS LEVEL 3 UPGRADE PER FIXTURE VOSS AND ALIGN



ALIGN (BN)



ALIGN (CH)



ALIGN (MB)



PLUMBING FIXTURES

****** MOEN PRODUCTS ONLY******

TUB FILLERS LEVEL 4 UPGRADE PER FIXTURE WEYMOUTH



WEYMOUTH (BN)



WEYMOUTH (CH)



WEYMOUTH (ORB)

PLUMBING FIXTURES

****** MOEN PRODUCTS ONLY******

TUB FILLERS LEVEL 4 UPGRADE PER FIXTURE WEYMOUTH



WEYMOUTH (MB)



WEYMOUTH (BG)

PLUMBING FIXTURES

****** MOEN PRODUCTS ONLY******

TUB FILLERS WITH WAND UPGRADE PER FIXTURE



BRANTFORD (BN)



BRANTFORD (CH)



BRANTFORD (ORB)



PLUMBING FIXTURES

****** MOEN PRODUCTS ONLY******

TUB FILLERS WITH WAND LEVEL 1 PER FIXTURE



EVA (BN)



EVA (CH)



EVA (ORB)



PLUMBING FIXTURES

****** MOEN PRODUCTS ONLY******

TUB FILLERS WITH WAND LEVEL 2 PER FIXTURE



ALIGN (BN)



ALIGN (CH)



ALIGN (BG)



PLUMBING FIXTURES

****** MOEN PRODUCTS ONLY******

TUB FILLERS WITH WAND LEVEL 3 UPGRADE PER FIXTURE



WEYMOUTH (BN)



WEYMOUTH (CH)



WEYMOUTH (ORB)

PLUMBING FIXTURES

****** MOEN PRODUCTS ONLY******

TUB FILLERS WITH WAND LEVEL 3 UPGRADE PER FIXTURE



WEYMOUTH (MB)



WEYMOUTH (BG)

*** ADDING SHOWER HEADS AND RAINHEADS MUST BE APPROVED AND BID IN ORIGINAL HOUSE PLAN***

NOTE: SHOWER HEADS STUBBED OUT AT 80" FROM FLOOR





PLUMBING FIXTURES

****** MOEN PRODUCTS ONLY******

UPGRADES

*50-GAL. GAS WATER HEATER	QUOTED
*TANKLESS GAS WATER HEATER	QUOTED
*GAS DROPS	QUOTED
**BOOSTED WATER PUMP	QUOTED
HOSE BIBS (2-INCLUDED)	QUOTED
GARAGE SINK	QUOTED

*DOES NOT INCLUDE GAS TANK

**REQUIRES ADDITIONAL ELECTRICAL, TRENCHING, AND CONCRETE PAD



SHOWER DOORS

INCLUDED – MASTER SHOWER – FRAMLESS



-BRUSHED NICKEL
-OIL RUBBED BRONZE
-MATTE BLACK (**SPECIAL ORDER**)



SHOWER DOORS



**UPGRADE – SEMI-FRAMELESS BYPASS SLIDER SHOWER ENCLOSURE
60" X 72"**

UPGRADE – FRAMELESS GLASS SHOWER – MUST BE QUOTED (PICTURED)



MIRRORS

INCLUDED – UNFRAMED MIRROR, 42" TALL X LENGTH OF COUNTERTOP



UPGRADE - FRAMED WITH COLONIAL OR CRAFTSMAN TRIM – EACH



COLONIAL



CRAFTSMAN



COUNTERTOPS

INCLUDED – LEVEL 1 / A



CALEDONIA

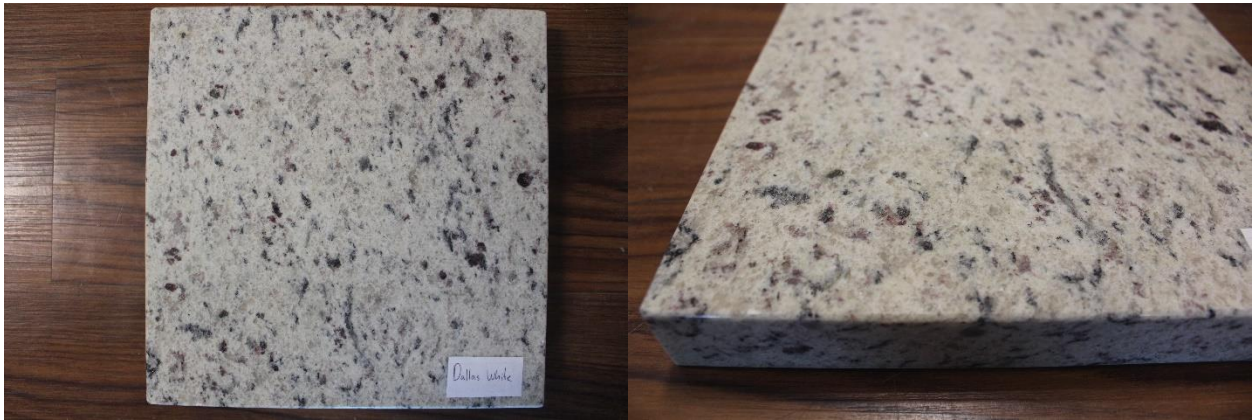

DALLAS WHITE



SANTA CECILIA



COUNTERTOPS

INCLUDED – LEVEL 1 / A



UBATUBA



VALLE NEVADO



COUNTERTOPS

EDGE PROFILES

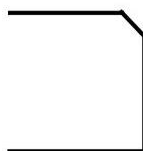

Bevel 1/4"

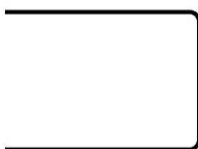

Square

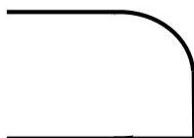

Waterfall

***NO REMNANTS

***IF SELECTING MULTIPLE TYPES, COST WILL INCREASE.



KITCHEN SINKS

LEVEL 1 - INCLUDED

30" UNDERMOUNT / STAINLESS STEEL / STANDARD RADIUS / 16 GA.
SINGLE BOWL 40/60 50/50-TYPICAL 60/40

Dakota™
Quality for Life

Signature COLLECTION | **R-Series**

DSR-3018
UPC: 813649021196



Style:

- Standard Radius
- Undermount
- Kitchen Sink
- Single Bowl



Size:

- Overall: 30"x18.125"x9"
- Bowl Size: 28"x16.125"x9"

Features:

- 16 Gauge Thickness
- 304 Stainless Steel Sink
- 18/10 Chrome/Nickel Content
- Extra Large Sound Cancellation Pads
- Thermal Undercoating

Certifications:

- cUPC
- NGA ISO 9001
- UKAS
- CSA

Warranty:

- Lifetime Limited Warranty

Bulk Available:

- DSR-3018B

Available Color/Finish

- Brushed Nickel

Included Accessories:

- Bottom Grid(s): DSR-BG3018
- Basket Strainer: DSA-PB555
- 11 Piece Kitchen Kit*

*Sink kits only available with boxed non-bulk orders

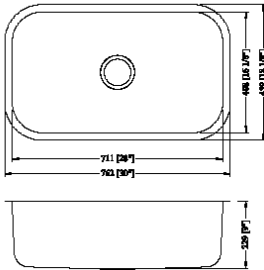

© 2018 Dakota Plumbing Products, LLC | Call: 954-987-3430 or Fax: 954-987-3434

DakotaSinks.com

Dakota™
Quality for Life

Signature COLLECTION | **R-Series**

DSR-4060
UPC: 813649021233



Style:

- Standard Radius
- Undermount
- Kitchen Sink
- 40/60 Offset Double Bowl



Size:

- Overall: 32"x20.75"x9"
- Bowl Size: (L)13"x16.5"x9" | (R)15.75"x18.75"x9"

Features:

- 16 Gauge Thickness
- 304 Stainless Steel Sink
- 18/10 Chrome/Nickel Content
- Extra Large Sound Cancellation Pads
- Thermal Undercoating

Certifications:

- cUPC
- NGA ISO 9001
- UKAS
- CSA

Warranty:

- Lifetime Limited Warranty

Bulk Available:

- DSR-4060B

Available Color/Finish

- Brushed Nickel

Included Accessories:

- Bottom Grid(s): DSR-BG4060
- Basket Strainer: DSA-PB555
- 11 Piece Kitchen Kit*

*Sink kits only available with boxed non-bulk orders

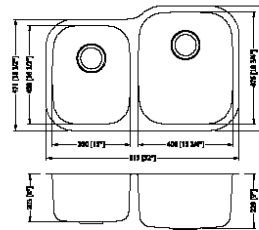

© 2018 Dakota Plumbing Products, LLC | Call: 954-987-3430 or Fax: 954-987-3434

DakotaSinks.com

Dakota™
Quality for Life

Signature COLLECTION | **R-Series**

DSR-5050
UPC: 813649020240



Style:

- Standard Radius
- Undermount
- Kitchen Sink
- 50/50 Straight-Cut Double Bowl



Size:

- Overall: 32.25"x18.5"x9"
- Bowl Size: (L)14.5"x16.5"x9" | (R)14.5"x16.5"x9"

Features:

- 16 Gauge Thickness
- 304 Stainless Steel Sink
- 18/10 Chrome/Nickel Content
- Extra Large Sound Cancellation Pads
- Thermal Undercoating

Certifications:

- cUPC
- NGA ISO 9001
- UKAS
- CSA

Warranty:

- Lifetime Limited Warranty

Bulk Available:

- DSR-5050B

Available Color/Finish

- Brushed Nickel

Included Accessories:

- Bottom Grid(s): DSR-BG5050
- Basket Strainer: DSA-PB555
- 11 Piece Kitchen Kit*

*Sink kits only available with boxed non-bulk orders

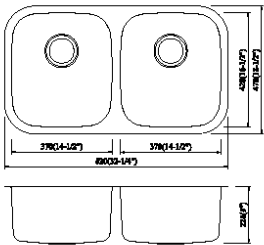

© 2018 Dakota Plumbing Products, LLC | Call: 954-987-3430 or Fax: 954-987-3434

DakotaSinks.com

Dakota™
Quality for Life

Signature COLLECTION | **R-Series**

DSR-6040
UPC: 813649021264



Style:

- Standard Radius
- Undermount
- Kitchen Sink
- 60/40 Offset Double Bowl



Size:

- Overall: 32"x20.75"x9"
- Bowl Size: (L)15.75"x18.75"x9" | (R)13.5"x16.5"x9"

Features:

- 16 Gauge Thickness
- 304 Stainless Steel Sink
- 18/10 Chrome/Nickel Content
- Extra Large Sound Cancellation Pads
- Thermal Undercoating

Certifications:

- cUPC
- NGA ISO 9001
- UKAS
- CSA

Warranty:

- Lifetime Limited Warranty

Bulk Available:

- DSR-6040B

Available Color/Finish

- Brushed Nickel

Included Accessories:

- Bottom Grid(s): DSR-BG6040-1
- Basket Strainer: DSA-PB555
- 11 Piece Kitchen Kit*

*Sink kits only available with boxed non-bulk orders

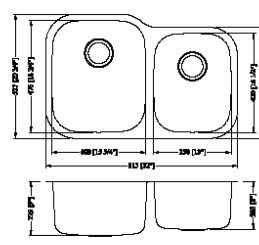

© 2018 Dakota Plumbing Products, LLC | Call: 954-987-3430 or Fax: 954-987-3434

DakotaSinks.com



KITCHEN SINKS

LEVEL 2 – UPGRADE -
30" UNDERMOUNT / STAINLESS STEEL / MICRO-RADIUS / 16 GA.
SINGLE BOWL 40/60 50/50 60/40

Dakota™
Quality for Life

Signature COLLECTION | **M-Series**



DSM-3018
UPC: 813649020922



Style:

- Micro Radius
- Undermount
- Kitchen Sink
- Single Bowl



Size:

- Overall: 30" x 18" x 10"
- Bowl Size: 28" x 16" x 10"

Features:

- 16 Gauge Thickness
- 304 Stainless Steel Sink
- 18/10 Chrome/Nickel Content
- Extra Large Sound Cancellation Pads
- Thermal Undercoating

Certifications:

- cUPC
- NGA ISO 9001
- UKAS
- CSA

Warranty:

- Lifetime Limited Warranty

Available Color/Finish

- Brushed Nickel

Included Accessories:

- Bottom Grid(s): DSM-BG3018
- Basket Strainer: DSA-PBSSS
- 11 Piece Kitchen Kit*

*Sink kits only available with boxed non-bulk orders

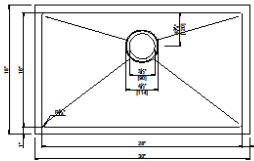
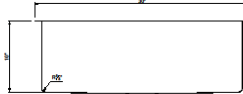

© 2018 Dakota Plumbing Products, LLC | Call: 954-987-3430 or Fax: 954-987-3434

DakotaSinks.com

Dakota™
Quality for Life

Signature COLLECTION | **M-Series**



DSM-4060
UPC: 813649021394



Style:

- Micro Radius
- Undermount
- Kitchen Sink
- 40/60 Straight-Cut Double Bowl



Size:

- Overall: 32" x 18" x 10"
- Bowl Size: (L) 12" x 16" x 10" | (R) 11" x 16" x 10"

Features:

- 16 Gauge Thickness
- 304 Stainless Steel Sink
- 18/10 Chrome/Nickel Content
- Extra Large Sound Cancellation Pads
- Thermal Undercoating

Certifications:

- cUPC
- NGA ISO 9001
- UKAS
- CSA

Warranty:

- Lifetime Limited Warranty

Available Color/Finish

- Brushed Nickel

Included Accessories:

- Bottom Grid(s): DSM-BG4060
- Basket Strainer: DSA-PBSSS
- 11 Piece Kitchen Kit*

*Sink kits only available with boxed non-bulk orders

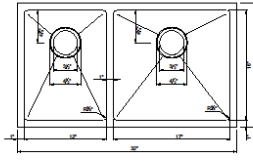
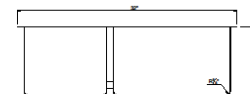

© 2018 Dakota Plumbing Products, LLC | Call: 954-987-3430 or Fax: 954-987-3434

DakotaSinks.com

Dakota™
Quality for Life

Signature COLLECTION | **M-Series**



DSM-5050
UPC: 813649020953



Style:

- Micro Radius
- Undermount
- Kitchen Sink
- 50/50 Straight-Cut Double Bowl



Size:

- Overall: 32" x 18" x 10"
- Bowl Size: (L) 14.5" x 16" x 10" | (R) 14.5" x 16" x 10"

Features:

- 16 Gauge Thickness
- 304 Stainless Steel Sink
- 18/10 Chrome/Nickel Content
- Extra Large Sound Cancellation Pads
- Thermal Undercoating

Certifications:

- cUPC
- NGA ISO 9001
- UKAS
- CSA

Warranty:

- Lifetime Limited Warranty

Available Color/Finish

- Brushed Nickel

Included Accessories:

- Bottom Grid(s): DSM-BG5050
- Basket Strainer: DSA-PBSSS
- 11 Piece Kitchen Kit*

*Sink kits only available with boxed non-bulk orders

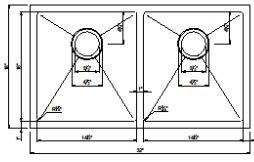
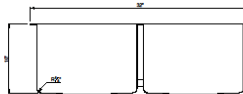

© 2018 Dakota Plumbing Products, LLC | Call: 954-987-3430 or Fax: 954-987-3434

DakotaSinks.com

Dakota™
Quality for Life

Signature COLLECTION | **M-Series**



DSM-6040
UPC: 813649020960



Style:

- Micro Radius
- Undermount
- Kitchen Sink
- 60/40 Straight-Cut Double Bowl



Size:

- Overall: 32" x 18" x 10"
- Bowl Size: (L) 17" x 16" x 10" | (R) 12" x 16" x 10"

Features:

- 16 Gauge Thickness
- 304 Stainless Steel Sink
- 18/10 Chrome/Nickel Content
- Extra Large Sound Cancellation Pads
- Thermal Undercoating

Certifications:

- cUPC
- NGA ISO 9001
- UKAS
- CSA

Warranty:

- Lifetime Limited Warranty

Available Color/Finish

- Brushed Nickel

Included Accessories:

- Bottom Grid(s): DSM-BG6040
- Basket Strainer: DSA-PBSSS
- 11 Piece Kitchen Kit*

*Sink kits only available with boxed non-bulk orders

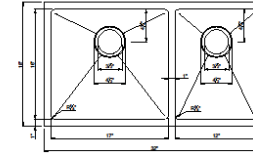
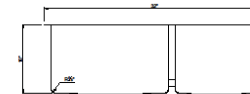

© 2018 Dakota Plumbing Products, LLC | Call: 954-987-3430 or Fax: 954-987-3434

DakotaSinks.com



KITCHEN SINKS

LEVEL 3 – UPGRADE -
30" UNDERMOUNT / STAINLESS STEEL / MICRO-RADIUS / APRON FRONT / 16 GA.
SINGLE BOWL 50/50 60/40

Dakota™
Quality for Life

Signature COLLECTION | **M-Series**



DSM-A3020
UPC: 813649021318



Style:

- Micro Radius
- Undermount
- Kitchen Sink
- Single Bowl
- Apron Front

Size:

- Overall: 30"x20"x10"
- Bowl Size: 27.125"x16"x10"

Features:

- 16 Gauge Thickness
- 304 Stainless Steel Sink
- 18/10 Chrome/Nickel Content
- Extra Large Sound Cancellation Pads
- Thermal Undercoating

Certifications:

- cUPC
- NGA ISO 9001
- UKAS
- CSA

Warranty:

- Lifetime Limited Warranty

Available Color/Finish

- Brushed Nickel

Included Accessories:

- Bottom Grid(s): DSM-BGA3020
- Basket Strainer: DSA-PB3SS
- 11 Piece Kitchen Kit*

*Sink kits only available with boxed non-bulk orders

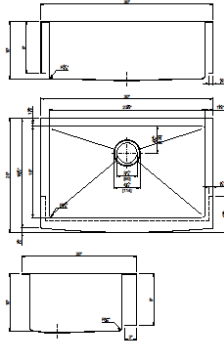

Dakota™
Quality for Life

Signature COLLECTION | **M-Series**



DSM-A5050
UPC: 813649021892



Style:

- Micro Radius
- Undermount
- Kitchen Sink
- 50/50 Straight-Cut Double Bowl
- Apron Front

Size:

- Overall: 33"x20"x10"
- Bowl Size: (L)14.625"x16.125"x10" | (R)14.625"x16.125"x10"

Features:

- 16 Gauge Thickness
- 304 Stainless Steel Sink
- 18/10 Chrome/Nickel Content
- Extra Large Sound Cancellation Pads
- Thermal Undercoating

Certifications:

- cUPC
- NGA ISO 9001
- UKAS
- CSA

Warranty:

- Lifetime Limited Warranty

Available Color/Finish

- Brushed Nickel

Included Accessories:

- Bottom Grid(s): DSM-BGA5050
- Basket Strainer: DSA-PB3SS
- 11 Piece Kitchen Kit*

*Sink kits only available with boxed non-bulk orders

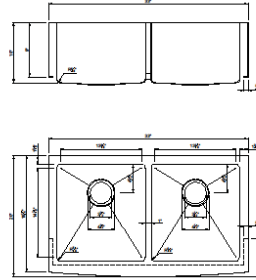

Dakota™
Quality for Life

Signature COLLECTION | **M-Series**



DSM-A6040
UPC: 813649020885



Style:

- Micro Radius
- Undermount
- Kitchen Sink
- 60/40 Straight-Cut Double Bowl
- Apron Front

Size:

- Overall: 33"x20"x10"
- Bowl Size: (L)17.375"x16"x10" | (R)11.625"x16"x10"

Features:

- 16 Gauge Thickness
- 304 Stainless Steel Sink
- 18/10 Chrome/Nickel Content
- Extra Large Sound Cancellation Pads
- Thermal Undercoating

Certifications:

- cUPC
- NGA ISO 9001
- UKAS
- CSA

Warranty:

- Lifetime Limited Warranty

Available Color/Finish

- Brushed Nickel

Included Accessories:

- Bottom Grid(s): DSM-BGA6040
- Basket Strainer: DSA-PB3SS
- 11 Piece Kitchen Kit*

*Sink kits only available with boxed non-bulk orders

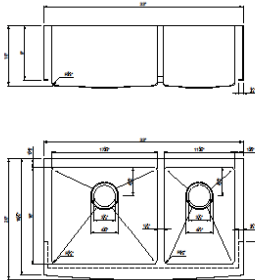

KITCHEN SINKS

LEVEL 4 – UPGRADE - 30" UNDERMOUNT / QUARTZ COMPOSITE SINGLE BOWL 40/60 50/50 60/40



GSE-QC3219
UPC:

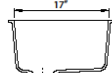
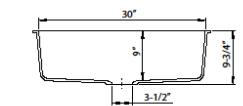
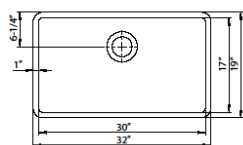

Style:

- Kitchen Sink
- Single Bowl
- Undermount

Material:

- Quartz Composite

Size:

- Overall: 32" x 19"
- Bowl Depth: 9-3/4"
- Drain Diameter: 3-1/2"

Features:

- Made from 80% quartz, only diamond is harder
- Durable; highly resistant to scratches and stains
- Non-porous surface, easy-to-clean
- Extremely hygienic, does not absorb bacteria
- Heat resistant to +500°F
- PerfectFit drains for easy cleaning

Certifications:

- Complies with ANSI Z124.6-2007
- Complies with EN 13310:2003

Warranty:

- Lifetime Limited Warranty

Available Color/Finish



Available Accessories (Not Included):

- Color Matched Bottom Grid(s)
- Color Matched Basket Strainer
- Color Matched Disposal Flange



© 2018 Dakota Plumbing Products, LLC | Call: 954-987-3430 or Fax: 954-987-3434

DakotaSinks.com

GSE-QC4060LD
UPC:

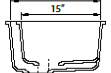
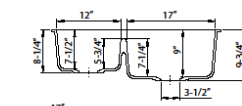
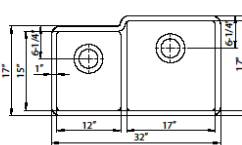

Style:

- Kitchen Sink
- 40/60 Double Bowl
- Low Divide
- Undermount

Material:

- Quartz Composite

Size:

- Overall: 32" x 19"
- Bowl Depth: 8-1/4" | 9-3/4"
- Drain Diameter: 3-1/2"

Features:

- Made from 80% quartz, only diamond is harder
- Durable; highly resistant to scratches and stains
- Non-porous surface, easy-to-clean
- Extremely hygienic, does not absorb bacteria
- Heat resistant to +500°F
- PerfectFit drains for easy cleaning

Certifications:

- Complies with ANSI Z124.6-2007
- Complies with EN 13310:2003

Warranty:

- Lifetime Limited Warranty

Available Color/Finish



Available Accessories (Not Included):

- Color Matched Bottom Grid(s)
- Color Matched Basket Strainer
- Color Matched Disposal Flange



© 2018 Dakota Plumbing Products, LLC | Call: 954-987-3430 or Fax: 954-987-3434

DakotaSinks.com



GSE-QC5050LD
UPC:

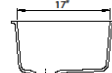
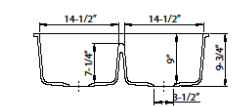
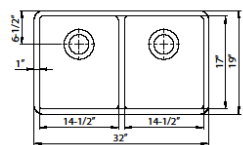

Style:

- Kitchen Sink
- 50/50 Double Bowl
- Low Divide
- Undermount

Material:

- Quartz Composite

Size:

- Overall: 32" x 19"
- Bowl Depth: 9-3/4" | 9-3/4"
- Drain Diameter: 3-1/2"

Features:

- Made from 80% quartz, only diamond is harder
- Durable; highly resistant to scratches and stains
- Non-porous surface, easy-to-clean
- Extremely hygienic, does not absorb bacteria
- Heat resistant to +500°F
- PerfectFit drains for easy cleaning

Certifications:

- Complies with ANSI Z124.6-2007
- Complies with EN 13310:2003

Warranty:

- Lifetime Limited Warranty

Available Color/Finish



Available Accessories (Not Included):

- Color Matched Bottom Grid(s)
- Color Matched Basket Strainer
- Color Matched Disposal Flange



© 2018 Dakota Plumbing Products, LLC | Call: 954-987-3430 or Fax: 954-987-3434

DakotaSinks.com

GSE-QC6040LD
UPC:

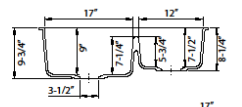
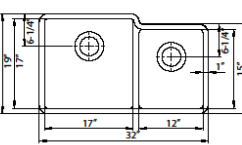

Style:

- Kitchen Sink
- 60/40 Double Bowl
- Undermount

Material:

- Quartz Composite

Size:

- Overall: 32" x 19"
- Bowl Depth: 9-3/4" | 8-1/4"
- Drain Diameter: 3-1/2"

Features:

- Made from 80% quartz, only diamond is harder
- Durable; highly resistant to scratches and stains
- Non-porous surface, easy-to-clean
- Extremely hygienic, does not absorb bacteria
- Heat resistant to +500°F
- Knockouts (ideal for traditional drop-in installations)
- PerfectFit drains for easy cleaning

Certifications:

- Complies with ANSI Z124.6-2007
- Complies with EN 13310:2003

Warranty:

- Lifetime Limited Warranty

Available Color/Finish



Available Accessories (Not Included):

- Color Matched Bottom Grid(s)
- Color Matched Basket Strainer
- Color Matched Disposal Flange



© 2018 Dakota Plumbing Products, LLC | Call: 954-987-3430 or Fax: 954-987-3434

DakotaSinks.com



KITCHEN SINKS

LEVEL 4 – UPGRADE - 30" UNDERMOUNT / FIRECLAY / FARMHOUSE SINGLE BOWL

DSE-FCA3018S: SIDE A: DOUBLE PIN-STRIPED / SIDE B: SCALLOPED
SIDE A: ¾ FRAME / SIDE B: FLAT

Dakota™
Quality for Life

Signature COLLECTION | Elements Series



DSE-FCA3018S
UPC: 613649026306

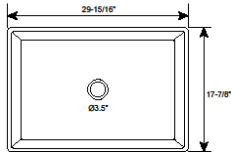

A surface

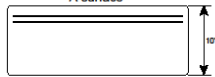

B surface



- Style:**
- Reversible Apron Front
 - Kitchen Sink
 - Single Bowl

Material:

- Fire Clay

Size:

- Overall: 29.9375"x17.875"x10"

- Features:**
- 2 Apron Styles
 - Apron 1: Double Pin-Striped
 - Apron 2: Scalloped

Certifications:

- cUPC
- NGA ISO 9001
- UKAS
- CSA

Warranty:

- Lifetime Limited Warranty



Available Color/Finish

- White

Dakota™
Quality for Life

Signature COLLECTION | Elements Series



DSE-FCA3019
UPC: 613649026313

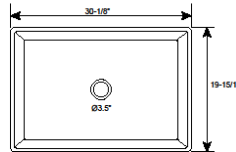

A surface

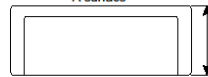

B surface



- Style:**
- Reversible Apron Front
 - Kitchen Sink
 - Single Bowl

Material:

- Fire Clay

Size:

- Overall: 30.125"x19.9375"x10"

- Features:**
- 2 Apron Styles
 - Apron 1: ¾ Frame
 - Apron 2: Flat

Certifications:

- cUPC
- NGA ISO 9001
- UKAS
- CSA

Warranty:

- Lifetime Limited Warranty



Available Color/Finish

- White

KITCHEN SINKS

LEVEL 5 – UPGRADE -
33" UNDERMOUNT / FIRECLAY / FARMHOUSE
SINGLE BOWL
SIDE A: FLAT OR SIDE B: FLAT



Signature | *Elements Series*
 COLLECTION



DSE-FCA3320
 UPC: 813649026320

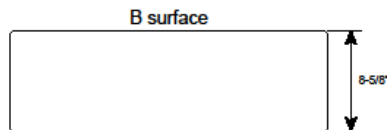
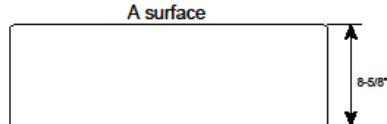
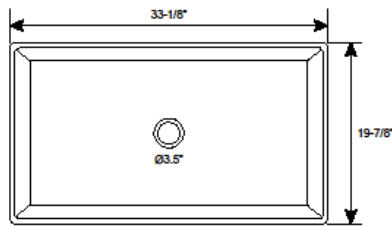

Style:

- Reversible Apron Front
- Kitchen Sink
- Single Bowl

Material:
 • Fire Clay

Size:

- Overall: 33.125"x19.875"x8.625"

Features:

- 2 Apron Sides
- Apron 1: Flat
- Apron 2: Flat

Certifications:

- cUPC
- NGA ISO 9001
- UKAS
- CSA

Warranty:

- Lifetime Limited Warranty



Available Color/Finish

-  White



KITCHEN SINKS

LEVEL 6 – UPGRADE -
33" UNDERMOUNT / FIRECLAY / FARMHOUSE
50/50
 SIDE A: DOUBLE PINSTRIPPED OR SIDE B: SCALLOPED

Dakota™
 Quality for Life

Signature | Elements Series
 COLLECTION



DSE-FCA5050S

UPC: 813649021295

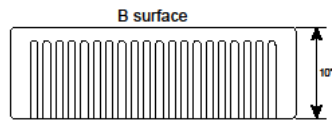
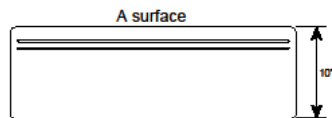
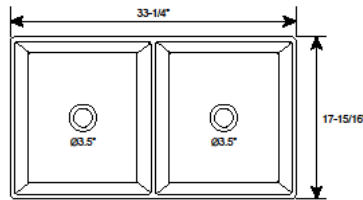

Style:

- Reversible Apron Front
- Kitchen Sink
- 50/50 Double Bowl

Material:

- Fire Clay

Size:

- Overall: 33.25"x17.9375"x10"

Features:

- 2 Apron Styles
- Apron 1: Double Pin-Striped
- Apron 2: Scalloped

Certifications:

- cUPC
- NQA ISO 9001
- UKAS
- CSA

Warranty:

- Lifetime Limited Warranty



Available Color/Finish

- White



BATH SINKS

Dakota™
Quality for Life

BUILDERS | **Universal**
COLLECTION | SERIES



US-1813
*SHOWN IN WHITE

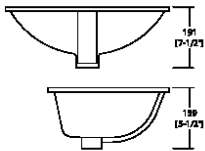
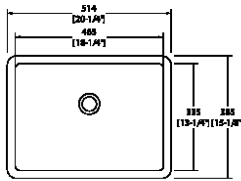

Style:

- Undermount
- Lavatory Sink
- Single Rectangle Bowl

Material:

- Porcelain

Size:

- Overall: 20.125"x15"x7.625"
- Bowl Size: 18.125"x13"x7.625"

Certifications:

- cUPC
- CSA

Important:

Dimensions of fixtures are nominal and may vary within the range of tolerances established by ANSI Standard A112.19.2. These measurements are subject to change or cancellation. No responsibility is assumed for use of superseded or voided pages.

Check Local Codes:

- Americans With Disabilities Act
- ANSI A117.1 Accessibility Standard

Warranty:

- Lifetime Limited Warranty

Available Color/Finish



Applies To Models:

- US-1813W UPC: 813649029840
- US-1813B UPC: 813649029826
- US-1813BK UPC: 813649029833

Dakota™
Quality for Life

BUILDERS | **Universal**
COLLECTION | SERIES



US-1714
*SHOWN IN WHITE

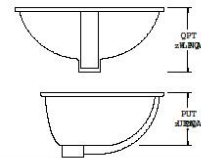
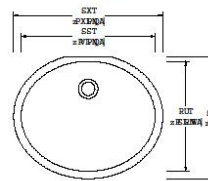

Style:

- Undermount
- Lavatory Sink
- Single Oval Bowl

Material:

- Porcelain

Size:

- Overall: 19.5" x 14" x 8.5"
- Bowl Size: 17.5" x 14.375" x 6.5"

Certifications:

- cUPC
- CSA

Important:

Dimensions of fixtures are nominal and may vary within the range of tolerances established by ANSI Standard A112.19.2. These measurements are subject to change or cancellation. No responsibility is assumed for use of superseded or voided pages.

Check Local Codes:

- Americans With Disabilities Act
- ANSI A117.1 Accessibility Standard

Warranty:

- Lifetime Limited Warranty

Available Color/Finish



Applies To Models:

- US-1714W UPC: 813649029758
- US-1714B UPC: 813649029727
- US-1714BO UPC: 813649029741
- US-1714BK UPC: 813649029734

AVAILABLE IN WHITE ONLY



BATHTUBS

INCLUDED

ACCORDING TO PLANS – MASTER TUB
ALCOVE SKIRTED TYPE
60”L X 32”W X 18”D



UPGRADE

MUST BE QUOTED

ROYAL BATH MANUFACTURING
JACUZZI
ACCORDING TO PLANS – MASTER TUB
TYPICAL IS A ROYAL BATHS: SPACE SAVER – DROP-IN
60”L X 32”W X 20”D

NON-JETTED
&
JETTED

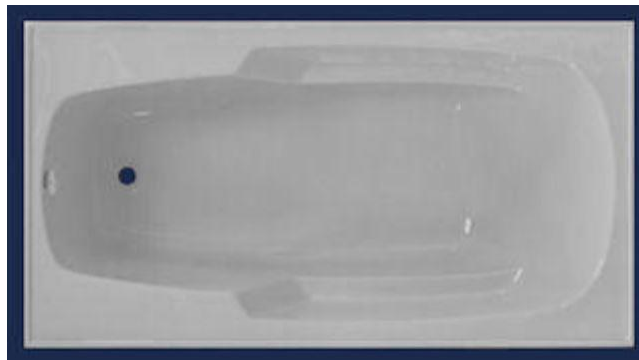

IF DIFFERENT THAN ABOVE: MUST BE COORDINATED WITH HOMEBUILDER
AND PRIOR TO FOUNDATION POUR.



BATH HARDWARE

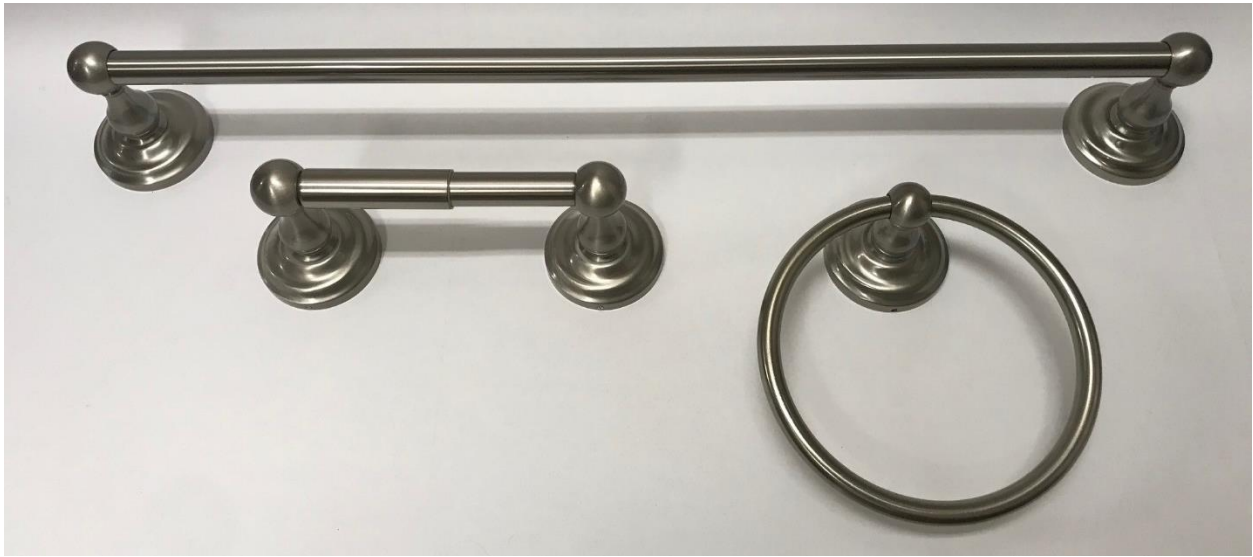

BRUSHED NICKEL



OIL RUBBED BRONZE
MATTE BLACK (**SPECIAL ORDER**)

APPLIANCES

INCLUDED PACKAGE



30" Free-standing Electric Convection Range

GE Appliances JB700SJSS



Interior Dishwasher With Hidden Controls

GE Appliances GDT655SSJSS



1.9 Cu. Ft. Over-the-range Sensor Microwave Oven

GE Appliances JVM7195SKSS



APPLIANCES

UPGRADE PACKAGE



Ge Profile™ Series Stainless Steel Interior Dishwasher With Hidden Controls

GE Appliances PDT845SSJSS



Ge Profile™ Series 2.1 Cu. Ft. Over-the-range Sensor Microwave Oven

GE Appliances PVM9215SFSS



Ge Profile™ Series 30" Free-standing Double Oven Convection Range

GE Appliances PB980SJSS



APPLIANCES

GAS PACKAGE

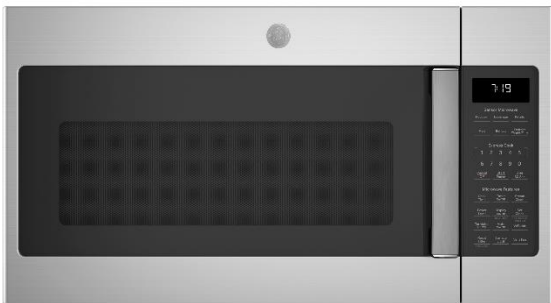

LIGHTING

PRODUCT LINE IS INCLUDED

CROSBY Brushed Nickel



43999NI
Dining - 5 Light
W: 26.25" x H: 22.25"



43998NI
Large Foyer/Stairs - 4 Light
W: 16.00" x H: 31.00"



43997NI
Breakfast - 3 Light
W: 18.00" x H: 13.75"



43997NI
Medium Foyer/Stairs - 3 Light
W: 18.00" x H: 13.75"



209NI
Halls/ Closets - 2 Light
Ceiling W: 9.00" x H: 5.00"



8112NI
Low Foyer/Stairs/Beds/Loft/Game - 2 Light
W: 13.25" x H: 6.00"



43996NI
Kitchen Pendant - 1 Light
W: 6.00" x H: 10.75"



45495NI
Wall Sconce - 1 Light
W: 4.50" x H: 9.25"



45496NI
Powder Bath - 2 Light
W: 15.00" x H: 8.75"



45497NI
Secondary Bath - 3 Light
W: 23.00" x H: 8.75"



45498NI
Master Bath - 4 Light
W: 31.00" x H: 8.75"



LIGHTING

PRODUCT LINE IS INCLUDED

CROSBY - Olde Bronze



43999OZ
Dining - 5 Light
W: 26.25" x H: 22.25"



43998OZ
Large Foyer/Stairs - 4 Light
W: 16.00" x H: 31.00"



43997OZ
Breakfast - 3 Light
W: 18.00" x H: 13.75"



43997OZ
Medium Foyer/Stairs - 3 Light
W: 18.00" x H: 13.75"



209OZ
Halls/ Closets - 2 Light
Ceiling W: 9.00" x H: 5.00"



8112OZ
Low Foyer/Stairs/Beds/Loft/Game - 2 Light
W: 13.25" x H: 6.00"



43996OZ
Kitchen Pendant - 1 Light
W: 6.00" x H: 10.75"



45495OZ
Wall Sconce - 1 Light
W: 4.50" x H: 9.25"



45496OZ
Powder Bath - 2 Light
W: 15.00" x H: 8.75"



45497OZ
Secondary Bath - 3 Light
W: 23.00" x H: 8.75"



45498OZ
Master Bath - 4 Light
W: 31.00" x H: 8.75"



LIGHTING

PRODUCT LINE IS INCLUDED

JOLIE Brushed Nickel Finish with Satin Etched Glass



43638NI
Dining - 5 Light
W: 22" X H: 18.5"



43639NI
Large Foyer/Stairs - 9 Light
W: 28" x H: 28"



43637NI
Breakfast - 3 Light
W: 18" x H: 18"



43641NI
Medium Foyer/Stairs - 2 Light
W: 15" x H: 13.75"



209NI
Halls/ Closets - 2 Light
W: 9.00" x H: 5.00



8112NI
Low Foyer/Stairs/Beds/Loft/ Game - 2 Light
W: 13.25" x H: 6.00 "



43640NI
Kitchen Pendant - 1 Light
W: 4.75" x H: 12.5"



45637NI
Wall Sconce - 1 Light
W: 5" x H: 9"



45638NI
Powder Bath - 2 Light
W: 13" x H: 9"



45639NI
Secondary Bath - 3 Light
W: 20.25" x H" 9"



45640NI
Master Bath - 4 Light
W: 28" x H: 9"



LIGHTING

PRODUCT LINE IS INCLUDED

JOLIE Olde Bronze Finish with Satin Etched Glass



43638OZ
Dining - 5 Light
W: 22" X H: 18.5"



43639OZ
Large Foyer/Stairs - 9 Light
W: 28" x H: 28"



43640OZ
Kitchen Pendant - 1 Light
W: 4.75" x H: 12.5"



43641OZ
Medium Foyer/Stairs - 2 Light
W: 15" x H: 13.75"



209OZ
Halls/ Closets - 2 Light
W: 9.00" x H: 5.00



8112OZ
Low Foyer/Stairs/Beds/Loft/ Game - 2 Light
W: 13.25" x H: 6.00 "



43640OZ
Kitchen Pendant - 1 Light
W: 4.75" x H: 12.5"



45637OZ
Wall Sconce - 1 Light
W: 5" x H: 9"



45638OZ
Powder Bath - 2 Light
W: 13" x H: 9"



45639OZ
Secondary Bath - 3 Light
W: 20.25" x H" 9"



45640OZ
Master Bath - 4 Light
W: 28" x H: 9"



LIGHTING

LEVEL 2

GRANBY Brushed Pewter Finish - 2 Bulb Flushmounts in Nickel Finish



42557BPT
Dining - 5 Light
W: 24.00" x H: 20.50"



42559BPT
Large Foyer/ Stairs - 9 Light
W: 33.25" x H: 32.00"



42561BPT
Breakfast - 3 Light
W: 24.50" x H: 24.50"



42563BPT
Medium Foyer/ Stairs - 3 Light
W: 17.25" x H: 14.00"



209NI
Halls/ Closets - 2 Light
W: 9.00" x H: 5.00"



8112NI
Low Foyer/Stairs/Beds/Loft/ Game - 2 Light
W: 13.25" x H: 6.00"



42562BPT
Kitchen Pendant - 1 Light
W: 5.25" x H: 6.75"



45358BPT
Wall Sconce - 1 Light
W: 5.75" x H: 14.00"



45359BPT
Powder Bath - 2 Light
W: 17.00" x H: 9.50"



45360BPT
Secondary Bath - 3 Light
W: 25.00" x H: 9.50"



45361BPT
Master Bath - 4 Light
W: 32.75" x H: 9.50"



LIGHTING

LEVEL 2

GRANBY Olde Bronze



42557OZ
Dining - 5 Light
W: 24.00" x H: 20.50"



42559OZ
Large Foyer/ Stairs - 9 Light
W: 33.25" x H: 32.00"



42561OZ
Breakfast - 3 Light
W: 24.50" x H: 24.50"



42563OZ
Medium Foyer/ Stairs - 3 Light
W: 17.25" x H: 14.00"



209OZ
Halls/ Closets - 2 Light
W: 9.00" x H: 5.00"



8112NI
Low Foyer/Stairs/Beds/Loft/ Game - 2 Light
W: 13.25" x H: 6.00 "



42562OZ
Kitchen Pendant - 1 Light
W: 5.25" x H: 6.75"



45358OZ
Wall Sconce - 1 Light
W: 5.75" x H: 14.00"



45359OZ
Powder Bath - 2 Light
W: 17.00" x H: 9.50"



45360OZ
Secondary Bath - 3 Light
W: 25.00" x H: 9.50"



45361OZ
Master Bath - 4 Light
W: 32.75" x H: 9.50"



LIGHTING

LEVEL 2

BARRINGTON Light Wood Tone Finish and Distressed Black Metal w/ Clear Seeded Glass . 2 Bulb Flushmounts in Bronze Finish



34750
Dining - 5 Light
W: 24.02" x H: 18.98"



34823
Large Foyer/ Stairs - 4 Light
W: 21.22" x H: 20.76"



34751
Breakfast - 3 Light
W: 17.99" x H: 16.57"



34753
Medium Foyer/ Stairs - 4
Light W: 12.01" x H: 23.31"



2090Z
Halls/Closets - 2 Light
W: 9.00" x H: 5.00"



81120Z
Low Foyer/Stairs/Beds/LoftGame- 2 Light
W: 13.25" x H: 6.00"



34810
Kitchen Pendant -1 Light
Pendant W: 5.50" x H: 10.00"



37400
Wall Sconce - 1 Light
W: 4.49" x H: 8.70"



37421
Secondary Bath - 3 Light
W: 22.00" x H: 9.00"



37435
Master Bath - 4 Light
Width: 29.50" x Height: 9.12"



LIGHTING

LEVEL 2

BARRINGTON Dark Wood Tone Finish and Distressed Black Metal w/Clear Seeded Glass. 2 Bulb Flushmounts in Bronze Finish



34686
Dining - 5 Light
W: 24.02" x H: 18.98"



34822
Large Foyer/ Stairs - 4 Light
W: 21.22" x H: 20.76"



34687
Breakfast - 3 Light
W: 17.99" x H: 16.57"



34689
Medium Foyer/ Stairs - 4
Light W: 12.01" x H: 23.31"



2090Z
Halls/Closets - 2 Light
W: 9.00" x H: 5.00"



81120Z
Low Foyer/Stairs/Beds/LoftGame- 2 Light
W: 13.25" x H: 6.00"



34808
Kitchen Pendant -1 Light
Pendant W: 5.50" x H: 10.00"



37376
Wall Sconce - 1 Light
W: 4.49" x H: 8.70"



37418
Secondary Bath - 3 Light
W: 22.00" x H: 9.00"



37423
Master Bath - 4 Light
Vanity W: 29.50" x H: 9.12"



LIGHTING

LEVEL 3

SHAILENE - Brushed Nickel



43671NI
Dining- 5 Light
W: 23.50" x H:
18.25"



43672NI
Large Foyer/Stairs- 9 Light
W: 26.25" x H: 26.50"



43670NI
Breakfast- 3 Light W:
17.50" x H: 15.25"



43692NI
Medium Stairs- 3 Light
W: 18" x H: 11.25"



209NI
Halls/ Closets - 2 Light
W: 9.00" x H: 5.00"



8112NI
Low Foyer/Stairs/Beds/Loft/Game - 2 Light
W: 13.25" x H: 6.00"



43674NI
Kitchen Pendant- 1 Light
W: 4.25" x H: 11"



45572NI
Wall Sconce - 1 Light
W: 5.50" x H: 1 0.75"



45573NI
Powder Bath- 2 Light
W: 12.50" x H: 8.25"



45574NI
Secondary Bath- 3 Light
W: 21" x H: 8.25"



45575NI
Master Bath- 4 Light
W: 29.50" x H: 8.25"



LIGHTING

LEVEL 3

SHAILENE - Olde Bronze



43671OZ
Dining- 5 Light
W: 23.50" x H: 18.25"



43672OZ
Large Foyer/Stairs- 9 Light
W: 26.25" x H: 26.50"



43670OZ
Breakfast- 3 Light
W: 17.50" x H: 15.25"



43692OZ
Medium Stairs- 3 Light
W: 18" x H: 11.25"



209OZ
Halls/ Closets - 2 Light
W: 9.00" x H: 5.00"



8112OZ
Low Foyer/Stairs/Beds/Loft/Game - 2 Light
W: 13.25" x H: 6.00"



43674OZ
Kitchen Pendant- 1 Light
W: 4.25" x H: 11"



45572OZ
Wall Sconce - 1 Light
W: 5.50" x H: 10.75"



45573OZ
Powder Bath- 2 Light
W: 12.50" x H: 8.25"



45574OZ
Secondary Bath- 3 Light
W: 21" x H: 8.25"



45575OZ
Master Bath- 4 Light
W: 29.50" x H: 8.25"



LIGHTING

Optional Pendants

Kitchen/Baths/Night Stands



42046 CH
Everly™
1-Light, 100-W
W. 13.75", H. 19", Ovrll. 60"



42046 OZ
Everly™
1-Light, 100-W
W. 13.75", H. 19", Ovrll. 60"



42046 NICS
Everly™
1-Light, 100-W
W. 13.75", H. 19", Ovrll. 60"



42046 OZCS
Everly™
1-Light, 100-W
W. 13.75", H. 19", Ovrll. 60"



42047 CH
Everly™
1-Light, 100-W
W. 8.75", H. 17", Ovrll. 58"



42047 OZ
Everly™
1-Light, 100-W
W. 8.75", H. 17", Ovrll. 58"



42588 OZ
Holbrook™
2-Light, 60-W
W. 10", H. 12", Ovrll. 50"



42588 NI
Holbrook™
2-Light, 60-W
W. 10", H. 12", Ovrll. 50"



49446 AZ
Lyndon™
1-Light, 75-W
W. 5", H. 9.5", Ovrll. 48"



49447 AZ
Lyndon™
1-Light, 100-W
W. 6", H. 11.75", Ovrll. 50"



49446 BA
Lyndon™
1-Light, 75-W
W. 5", H. 9.5", Ovrll. 48"



49447 BA
Lyndon™
1-Light, 100-W
W. 6", H. 11.75", Ovrll. 50"

Measurements shown in inches.

U.S. & Canada Patent Pending.



LIGHTING

Optional Pendants

Kitchen/Baths/Night Stands



2665 PN
Hatteras Bay™
1-Light, 100-W
W. 11.75", H. 10.25", Ovrll. 49"



2665 OZ
Hatteras Bay™
1-Light, 100-W
W. 11.75", H. 10.25", Ovrll. 49"



2666 PN
Hatteras Bay™
1-Light, 150-W
W. 13.25", H. 11.5", Ovrll. 50"



2666 OZ
Hatteras Bay™
1-Light, 150-W
W. 13.25", H. 11.5", Ovrll. 50"



43764 PN
Hatteras Bay™
1-Light, 100-W
W. 8", H. 10.25", Ovrll. 48"



43765 PN
Hatteras Bay™
1-Light, 100-W
W. 11.75", H. 12", Ovrll. 50"



43767 PN
Hatteras Bay™
1-Light, 150-W
W. 18", H. 16.75", Ovrll. 55"



43764 OZ
Hatteras Bay™
Mini Pendant
1-Light, 100-W
W. 8", H. 10.25", Ovrll. 48"



43765 OZ
Hatteras Bay™
Pendant
1-Light, 100-W
W. 11.75", H. 12", Ovrll. 50"



43767 OZ
Hatteras Bay™
Pendant
1-Light, 150-W
W. 18", H. 16.75", Ovrll. 55"



LIGHTING

Optional Pendants

Kitchen/Baths/Night Stands



43850 NI
Avery
1-Light, 100-W
W. 8", H. 8.5",
Ovrll. 125"



43851 NI
Avery
1-Light, 100-W
W. 8.25", H. 8.75",
Ovrll. 125"



43852 NI
Avery
1-Light, 100-W
W. 9.75", H. 11.25",
Ovrll. 128"



43853 NI
Avery
1-Light, 100-W
W. 10", H. 9.25",
Ovrll. 125"



43850 OZ
Avery
1-Light, 100-W
W. 8", H. 8.5",
Ovrll. 125"



43851 OZ
Avery
1-Light, 100-W
W. 8.25", H. 8.75",
Ovrll. 125"



43852 OZ
Avery
1-Light, 100-W
W. 9.75", H. 11.25",
Ovrll. 128"



43853 OZ
Avery
1-Light, 100-W
W. 10", H. 9.25",
Ovrll. 125"



42434 NI
Caparros™
1-Light, 100-W,
W. 6", H. 7.75", Ovrll. 46"



42436 AP
Sayre™
1-Light, 60-W
W. 10", H. 8.5", Ovrll. 46.5"



42436 OZ
Sayre™
1-Light, 60-W
W. 10", H. 8.5", Ovrll. 46.5"



LIGHTING

Optional Pendants

Kitchen/Baths/Night Stands



78200
Missoula™
1-Light, 100-W
W. 13.5", H. 12.75"



78200 AP
Missoula™
1-Light, 100-W
W. 13.5", H. 12.75"



43953 NI
Riviera
1-Light, 60-W
W. 7.5", H. 13.75", Ovrll. 52"



43954 NI
Riviera
1-Light, 60-W
W. 7.5", H. 13.75", Ovrll. 52"



43955 NI
Riviera
1-Light, 60-W
W. 11.5", H. 13", Ovrll. 51"



LIGHTING

EXTERIOR COACH LIGHTS

9789 BK TOWNHOUSE IS INCLUDED. ALL OTHERS ARE UPGRADES.

Exterior



9789 BK
Townhouse™
Front Door, Garage Front
1-Light, 100-W,
W. 7.25", H. 15.25", Ext. 9"



49552 BKT
Tolerand™
Garage Front
1-Light, 75-W
W. 5.75", H. 12", Ext. 6.5"



49553 BKT
Tolerand™
Front Column
1-Light, 100-W
W. 7.75", H. 17.75", Ext. 8.5"



49554 BKT
Tolerand™
Front Porch
1-Light, 150-W
W. 9.5", H. 20.25", Ext. 10.25"

INCLUDED



49775BK
Northland
Garage Front
1-Light, 60-W
W. 10", H. 12", Ext. 17.25"



49775BA
Northland
Garage Front
1-Light, 60-W
W. 10", H. 12", Ext. 17.25"



49776 BK
Northland
Front Porch
1-Light, 150-W
W. 14", H. 16.75", Ext. 24"



49776 BA
Northland
Front Porch
1-Light, 150-W
W. 14", H. 16.75", Ext. 24"



49800BKTLED
Ashton LED
Front Column
4 LED, 3000K, 2125Lm
W. 10", H. 24", Ext. 3"



49799BKTLED
Ashton LED
Front Porch
4 LED, 3000K, 1675Lm
W. 8.25", H. 15", Ext. 3"



49798BKTLED
Ashton LED
Garage Front
4 LED, 3000K, 525Lm
W. 5", H. 12", Ext. 3"

\$160/EA.

\$130/EA.

\$110/EA.



LIGHTING

EXTERIOR COACH LIGHTS

9789 BK TOWNHOUSE IS INCLUDED. ALL OTHERS ARE UPGRADES.

Exterior



FANS

INCLUDED

52" Basics Pro Select

Interior Fans Ideal For The Following Room Locations: Family Room, Living Room, Study, Bedrooms, Game Room, Sun Room, Play Room, And Media Room



330017SNB
Basics Pro Select LED
 Ceiling Fan with LED Light
 Satin Natural Bronze Finish with
 White Etched Glass
 Replaceable. Includes (3)
 B10, 4W LED Bulbs
 52" Blade Sweep
 Reversible Walnut/Silver Blades
 3-Speeds, Forward & Reverse
 Pull Chain Control



330017NI
Basics Pro Select LED
 Ceiling Fan with LED Light
 Brushed Nickel Finish with
 White Etched Glass
 Replaceable. Includes (3)
 B10, 4W LED Bulbs
 52" Blade Sweep
 Reversible Walnut/Silver Blades
 3-Speeds, Forward & Reverse
 Pull Chain Control



337001 WH
Basic Hand Held Control System
 Interior Fans Only
 3 Speed Motor Control & Off
 Light On/Off with Full Range
 Dimming, Manual Reverse,

AIR PERFORMANCE		
AIRFLOW Cubic Ft. Per Minute on High	POWER USAGE Watts on High (Excludes Lights)	AIRFLOW EFFICIENCY Cubic Ft. Per Minute Per Watt
4200	52	81

Measurements shown in inches.

U.S. Patent Pending.



EXTERIOR FANS

INCLUDED

52" Basics Pro Patio Fan



380902SNB LIGHT KIT
330015SNB FAN



380902SBK LIGHT KIT
330015SBK FAN



380902WH LIGHT KIT
330015WH FAN



FANS

52" Canfield™ Select

Interior Fans Ideal For The Following Room Locations: Family Room, Living Room, Study, Bedrooms, Game Room, Sun Room, Play Room, And Media Room



300026 OBB
Canfield Select LED
 Ceiling Fan with LED Light
 Oil Brushed Bronze Finish
 52" Blade Sweep
 LED Platform, 1,600 Lumens,
 80 CRI, 3,000K CCT
 Reversible Walnut/Cherry Blades,
 Cased Opal Glass
 Reversible, 3-speeds



300026 BSS
Canfield Select LED
 Ceiling Fan with LED Light
 Brushed Stainless Steel Finish
 52" Blade Sweep
 Removable, 17-W Dimmable
 LED Platform, 1,600 Lumens,
 80 CRI, 3,000K CCT
 Reversible Oak Blades,
 Cased Opal Glass
 Reversible, 3-speeds



AIR PERFORMANCE		
AIRFLOW Cubic Ft. Per Minute on High	POWER USAGE Watts on High (Excludes Lights)	AIRFLOW EFFICIENCY Cubic Ft. Per Minute Per Watt
5356	58	86



FANS

52" Starkk™ LED

Interior Fans Ideal For The Following Room Locations: Family Room, Living Room, Study, Bedrooms, Game Room, Sun Room, Play Room, And Media Room

LED



330174 OZ Starkk
Ceiling Fan with LED Light
Olde Bronze with Satin Etched Glass
Integrated. 17-W Dimmable
LED Platform. 1,600 Lumens,
80 CRI, 3,000K CCT
52" Blade Sweep
Reversible Walnut/Cherry Blades
Pull Chain Control



330174 NI Starkk LED
Ceiling Fan with LED Light
Brushed Nickel Finish
with Satin Etched Glass
Integrated. 17-W Dimmable
LED Platform. 1,600 Lumens,
80 CRI, 3,000K CCT
52" Blade Sweep
Reversible Walnut/Silver Blades
Pull Chain Control



AIR PERFORMANCE		
AIRFLOW Cubic Ft. Per Minute on High	POWER USAGE Watts on High (Excludes Lights)	AIRFLOW EFFICIENCY Cubic Ft. Per Minute Per Watt
4051	54	75



FANS

52" Lucian™ LED

Interior Fans Ideal For The Following Room Locations: Family Room, Living Room, Study, Bedrooms, Game Room, Sun Room, Play Room, And Media Room

LED



330000 OZ
Lucian
Ceiling Fan with LED Light
Olde Bronze Finish with
Etched Cased Opal Glass
Integrated. 17-W LED Platform 1,600 Lm,
80 CRI, 3,000 CCT
52" Blade Sweep
Reversible Walnut/Cherry Blades (5)
Wall Transmitter Basic Included



330000 NI
Lucian
Ceiling Fan with LED Light
Brushed Nickel Finish with
Etched Cased Opal Glass Integrated.
17-W LED Platform 1,600 Lm,
80 CRI, 3,000 CCT
52" Blade Sweep
Reversible Walnut/Silver Blades (5)
Wall Transmitter Basic Included



330000 PN
Lucian
Ceiling Fan with LED Light
Brushed Nickel Finish with
Etched Cased Opal Glass Integrated.
17-W LED Platform 1,600 Lm,
80 CRI, 3,000 CCT
52" Blade Sweep
Reversible Black/Silver Blades (5)
Wall Transmitter Basic Included



Included Control
WALL TRANSMITTER – BASIC
-3 Forward Speeds & Motor Off
-Manual Reverse
-Lights On/Off with Full Range
-Dimming & Intelligent Return
-Faceplate Included

AIR PERFORMANCE		
AIRFLOW	POWER	AIRFLOW
Cubic Ft. Per Minute on High	USAGE Watts on High (Excludes Lights)	EFFICIENCY Cubic Ft. Per Minute Per Watt
5356	72	75



FANS

60" Ashbyrn™ **Large Interior Fans**
Ideal For Large Living Spaces



300269 AP
Ashbyrn
Interior Ceiling Fan
Antique Pewter Finish
Light Kit Adaptable
60" Blade Sweep
Reversible Weathered White Walnut/
Dark Cherry Blades
3-Speeds, Reversible, Pull Chain Control



AIR PERFORMANCE		
AIRFLOW Cubic Ft. Per Minute on High	POWER USAGE Watts on High (Excludes Lights)	AIRFLOW EFFICIENCY Cubic Ft. Per Minute Per Watt
6698	82	81



FANS

52" Canfield™ Patio

Exterior Fans Ideal For The Following Room Locations:
Covered Patio, Third Car Garage, and Deck



310192 TZP
Canfield™ Patio
Exterior Fan
Tannery Bronze Powder Coat Finish
52" Blade Sweep
Cherry/Walnut Reversible Blades,
3-Speed, Pull Chain Control



AIR PERFORMANCE		
AIRFLOW Cubic Ft. Per Minute on High	POWER USAGE Watts on High (Excludes Lights)	AIRFLOW EFFICIENCY Cubic Ft. Per Minute Per Watt
5481	71	78



FANS

52" Cameron™

Exterior Fans Ideal For The Following Room Locations:
Covered Patio, Third Car Garage, and Deck



310104 WCP
Weathered Copper Powder Coat Finish
With Etched Cased Opal Glass
Integrated, 3 E-12 40-W Krypton/T3Lamps
Walnut Reversible Blades
52" Blade Sweep
Basic CoolTouch
Control System Included



Included Control
COOLTOUCH™ CONTROL SYSTEM – BASIC
-3 Forward Speeds
-Manual Reverse
-Lights On/Off
-Motor Off

AIR PERFORMANCE		
AIRFLOW Cubic Ft. Per Minute on High	POWER USAGE Watts on High (Excludes Lights)	AIRFLOW EFFICIENCY Cubic Ft. Per Minute Per Watt
4955	62	79



FANS

Arkwet™ CLIMATES

Exterior Fans Ideal For The Following Room Locations:
Covered Patio, Third Car Garage, and Deck



339629 WSP
Arkwet™ CLIMATES
Exterior Fan
Weathered Steel Finish
52" Blade Sweep
Satin Black/Silver Blades
Pull Chain Control

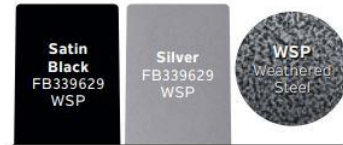

AIR PERFORMANCE		
AIRFLOW Cubic Ft. Per Minute on High	POWER USAGE Watts on High (Excludes Lights)	AIRFLOW EFFICIENCY Cubic Ft. Per Minute Per Watt
5024	49	103

Measurements shown in inches.

U.S. Patent Pending.



FANS

52" Kichler LED **Interior Fans** Ideal For The Following Room Locations: Family Room, Living Room, Study, Bedrooms, Game Room, Sun Room, Play Room, And Media Room



35163
LED Indoor/Outdoor Fan
Weathered Zinc Finish
with Etched Glass
52" Blade Sweep
Weathered Wood Blades
Included Remote Control



FANS

52" Colerne™ LED Interior Fans Ideal For The Following Room Locations: Family Room, Living Room, Study, Bedrooms, Game Room, Sun Room, Play Room, And Media Room

LED



300027AP
Ridley™ II LED
Interior Ceiling Fan with LED Light
Antique Pewter Finish
with Etched Cased Opal Glass
52" Blade Sweep
(3) Medium Oak Blades
3-Speeds
Wall Control System Included

Weathered
White
Walnut
FB300027
AP

AP
Antique
Pewter

AIR PERFORMANCE		
AIRFLOW Cubic Ft. Per Minute on High	POWER USAGE Watts on High (Excludes Lights)	AIRFLOW EFFICIENCY Cubic Ft. Per Minute Per Watt
4388	50	87

Measurements shown in inches.

U.S. Patent Pending.



FANS

85" Gentry LED **Large Interior Fans** Ideal For Large Living Spaces



300285 AVI
Gentry LED
Interior Ceiling Fan with Light
Anvil Iron Finish with Cased Opal Glass
Downlight Replaceable, 17W Dimmable Integrated
LED Platform, 1,600 Lumens, 3,000K
85" Blade Sweep
Reversible Distressed Antique Gray/Walnut Blades
6-Speed DC Wall Control System



6-Speed DC Wall Control System
- 6 Forward Speeds, Reverse & Motor Off
- Lights On/Off with Full-Range Dimming
- No More Than Two Fans on One Circuit
- Faceplates Included in 3 Colors

AIR PERFORMANCE		
AIRFLOW Cubic Ft. Per Minute on High	POWER USAGE Watts on High (Excludes Lights)	AIRFLOW EFFICIENCY Cubic Ft. Per Minute Per Watt
8061	34	237

Measurements shown in inches.

U.S. Patent Pending.



FANS

60"/80"/96" Szepló™ II LED

Exterior Fans Ideal For The Following Room Locations:
Covered Patio, Third Car Garage, and Deck



300300SBK
Szepló™ II LED
Interior/Exterior Ceiling Fan
with LED Light
Satin Black Finish
with Etched Cased Opal Glass
17-W Dimmable LED Platform
1,600 Lumens, 80 CRI, 3,000K CCT
60" Blade Sweep
6-Speed DC Wall Control System Included

Satin Black
FB300300
SBK

SBK
Satin Black

AIR PERFORMANCE		
AIRFLOW Cubic Ft. Per Minute on High	POWER USAGE Watts on High (Excludes Lights)	AIRFLOW EFFICIENCY Cubic Ft. Per Minute Per Watt
7308	32	225



300301SBK
Szepló™ II LED
Interior/Exterior Ceiling Fan
with LED Light
Satin Black Finish
with Etched Cased Opal Glass
17-W Dimmable LED Platform
1,600 Lumens, 80 CRI, 3,000K CCT
80" Blade Sweep
6-Speed DC Wall Control System Included

Satin Black
FB300301
SBK

SBK
Satin Black

AIR PERFORMANCE		
AIRFLOW Cubic Ft. Per Minute on High	POWER USAGE Watts on High (Excludes Lights)	AIRFLOW EFFICIENCY Cubic Ft. Per Minute Per Watt
9890	35	282



300302 SBK
Szepló™ II LED
Interior/Exterior Ceiling Fan
with LED Light
Weathered Steel Finish
with Etched Cased Opal Glass
17-W Dimmable LED Platform
1,600 Lumens, 80 CRI, 3,000K CCT
96" Blade Sweep
6-Speed DC Wall
Control System Included

Olde Bronze®
FB300302
OZ

OZ
Olde Bronze®

AIR PERFORMANCE		
AIRFLOW Cubic Ft. Per Minute on High	POWER USAGE Watts on High (Excludes Lights)	AIRFLOW EFFICIENCY Cubic Ft. Per Minute Per Watt
12854	31	419

- Included Control
6-SPEED DC Wall Control System (Shown)
-3 Forward Speeds & Reverse
-Lights On/Off with
-Full Range Dimming
-Motor Off
-No more than two fans on one circuit
-White Faceplate Included

Measurements shown in inches.

U.S. Patent Pending.

FANS

60" Bowen™ Interior Fans Ideal For The Following Room Locations: Family Room, Living Room, Study, Bedrooms, Game Room, Sun Room, Play Room, And Media Room



330243 NI
Bowen
Interior Ceiling Fan
Brushed Nickel Finish
Light Kit Adaptable
60" Blade Sweep
Reversible Walnut/Silver Blades
3-Speeds, Reversible,
Pull Chain Control



330243 OZ
Bowen
Interior Ceiling Fan
Olde Bronze® Finish
Light Kit Adaptable
60" Blade Sweep
Reversible Walnut/Cherry Blades
3-Speeds, Reversible,
Pull Chain Control



AIR PERFORMANCE		
AIRFLOW Cubic Ft. Per Minute on High	POWER USAGE Watts on High (Excludes Lights)	AIRFLOW EFFICIENCY Cubic Ft. Per Minute Per Watt
5190	67	78

Measurements shown in inches.

U.S. Patent Pending.



FANS

52" Arkwet™ CLIMATES™

Exterior Fans Ideal For The Following Room Locations:
Covered Patio, Third Car Garage, and Deck



339629 WSP
Arkvet
Outdoor Ceiling Fan
(Shown with 338629)
Weathered Steel Finish
Light Kit Adaptable
52" Blade Sweep
Reversible Black/Silver Blades
3-Speeds, Reversible, Pull Chain Control

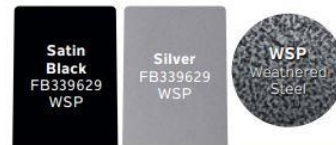

AIR PERFORMANCE		
AIRFLOW Cubic Ft. Per Minute on High	POWER USAGE Watts on High (Excludes Lights)	AIRFLOW EFFICIENCY Cubic Ft. Per Minute Per Watt
5024	49	103

Measurements shown in inches.

U.S. Patent Pending.



CABINET HARDWARE





CABINET HARDWARE

LEVEL 1 – INCLUDED

ALL PULLS - UPGRADE

LEVEL 2

UPGRADE / WHOLE HOME

LEVEL 3

UPGRADE / WHOLE HOME

ALL PULL UPGRADE

ROUTERED FINGER GROOVES

(40 DOORS AND 20 DRAWERS)



HANDRAILS



STANDARD / INCLUDED - ROUGH SAWN CEDAR / CATTLE PANEL

ONLY IF REQUIRED BY CODE.

42" WIDE STAIRS - STANDARD



HANDRAILS



QUOTED UPGRADE - ROUGH SAWN CEDAR / CEDAR SPINDLES

ONLY IF REQUIRED BY CODE.

42" WIDE STAIRS – STANDARD





PRE-CONSTRUCTION INFORMATION

PLUMBING

GAS SERVICE

TANK ONLY – STARTING PRICE
120-GALLON TANK - UPRIGHT
PER GAS-PLUMBING DROP

UPGRADES

*50-GAL. GAS WATER HEATER	QUOTED
*TANKLESS GAS WATER HEATER	QUOTED
*GAS DROPS	QUOTED
**BOOSTED WATER PUMP	QUOTED
QTY. 2-INCLUDED - HOSE BIBS	QUOTED
GARAGE SINK	QUOTED

ELECTRICAL

ELECTRICAL WALK-THROUGH IS CONDUCTED BEFORE SHEETROCK.

FLOOR PLUG:
WELDER PLUG-IN: (VOLTAGE? AMP? LOCATION?)
RV PLUG-IN: (VOLTAGE? AMP? LOCATION?)
(DOES NOT INCLUDE TRENCHING.)
USB PLUGS:
DIMMER CONTROLS:
OUTLET:
SWITCH CONTROLLED OUTLET:
6" CAN LIGHT (LED):

ALARM SYSTEM

INCLUDED

ONE (1) KEYPAD
ALARM CONTACTS ON ALL EXTERIOR DOORS
TWO (2) MOTION DETECTORS
ONE (1) SIREN
ONE (1) BACK-UP BATTERY

UPGRADES

EACH ADDITIONAL KEYPAD
EACH ADDITIONAL MOTION DETECTOR
EACH GLASS BREAK SENSOR





PRE-CONSTRUCTION INFORMATION

RV SEPTIC

EXTRA COSTPRE-PLAN***EXTRA PERMITTING***

REVERSE OSMOSIS DROPS

PER DROP

EXAMPLES

HOUSE REFRIGERATOR PRE-PLUMBED TO RO.

GARAGE REFRIGERATOR PRE-PLUMBED TO RO.

ICE MACHINE PRE-PLUMBED TO RO.

INSULATION

R-13 WALLS AND R-38 CEILING IS TYPICAL. UPGRADES AVAILABLE PRIOR TO CONSTRUCTION.





REFERRALS

ALARM

FEDERAL SECURITY SYSTEMS

DOUG DUDYCHA

210-260-2621

WATER SOFTENER

WATER SOLUTIONS

DARREN MCKINNEY

512-771-3556

GUTTERS

JUSTIN

512-470-5291

LANDSCAPE

SINGER SERVICES

TYLER SINGER

210-240-8055

